

SharePoint

Ntlangeni Andile Leon ▾ ?



KZN HEALTH

## KZN Health Intranet

Search this site



HOME CORPORATE INFORMATION COMPONENTS DIRECTORY DISTRICT OFFICES HEALTH FACILITIES

KZN Health &gt; Components &gt; Supply Chain Management

### AdvertQuote



## Quotation Advert

Opening Date: 2021-08-30

Closing Date: 2021-09-10

Closing Time: 11:00

### INSTITUTION DETAILS

Institution Name: Madadeni hospital

Province: KwaZulu-Natal

Department or Entity: Department of Health

Division or section: Central Supply Chain Management

Place where goods / services is required: Madadeni Hospital

Date Submitted: 2021-08-30

### ITEM CATEGORY AND DETAILS

Quotation Number: ZNQ: MAD/550/22

Item Category: Services

Item Description: Supply and install Extractor Fans in patients filling room.  
Requirements: CIDB: SO and GB

Quantity (if supplies): As per Specification

### COMPULSORY BRIEFING SESSION / SITE VISIT

Select Type: Compulsory Briefing Session

Date: 2021-09-03

Time: 11:00

Venue: Madadeni Hospital, Maintenance section

QUOTES CAN BE COLLECTED FROM: Quotes have been uploaded together with the advert. Service providers are requested to come with their documents.

QUOTES SHOULD BE DELIVERED TO: Quotes must be sent to [Madadeni.SCM@kznhealth.gov.za](mailto:Madadeni.SCM@kznhealth.gov.za) or hand deliver at Madadeni hospital, in the Admin tender box.

### ENQUIRIES REGARDING THE ADVERT MAY BE DIRECTED TO:

Name: Mr. AL Ntlangeni

Email:

Contact Number: 034 328 8269

**Finance Manager Name:**

Mr. MP Msomi

**Finance Manager Signature:**



A handwritten signature in black ink, consisting of a large loop followed by several smaller strokes, is written over a horizontal line.

No late quotes will be considered







**SPECIAL CONTRACT CONDITIONS OF QUOTATIONS****1. AMENDMENT OF CONTRACT**

- 1.1. Any amendment to or renunciation of the provisions of the contract shall at all times be done in writing and shall be signed by both parties.

**2. CHANGE OF ADDRESS**

- 2.1. Bidders must advise the Department of Health (institution where the offer was submitted) should their address (*domicilium citandi et executandi*) details change from the time of bidding to the expiry of the contract.

**3. GENERAL CONDITIONS ATTACHED TO THIS QUOTATION**

- 3.1. The institution is under no obligation to accept the lowest or any quote.
- 3.2. The price quoted must include VAT (if VAT vendor). However, it must be noted that the department reserves the right to evaluate all quotations excluding VAT as some bidders may not be VAT vendors.
- 3.3. The bidder must ensure the correctness & validity of quote:  
(i) *that the price(s), rate(s) & preference quoted cover all for the work/item (s) & accept that any mistakes regarding the price (s) & calculations will be at the bidder's risk*
- 3.4. The bidder must accept full responsibility for the proper execution & fulfilment of all obligations conditions devolving on under this agreement, as the Principal (s) liable for the due fulfilment of this contract.
- 3.5. This quotation will be evaluated based on the 80/20 points system, specification & correctness of information. All required documentation must be completed in full and submitted.
- 3.6. Offers must comply strictly with the specification.
- 3.7. Only offers that meet or are greater than the specification will be considered.
- 3.8. Late quotes will not be considered.
- 3.9. Expired product/s will not be accepted. All products supplied must be valid for a minimum period of six months.
- 3.10. A bidder not registered on the Central Suppliers Database or verification has failed will not be considered.
- 3.11. All delivery costs must be included in the quote price, for delivery at the prescribed destination.
- 3.12. Only firm prices will be accepted. Such prices must remain firm for the contract period. Non-firm prices (including rates of exchange variations) will not be considered.
- 3.13. In cases where different delivery points influence the pricing, a separate pricing schedule must be submitted for each delivery point.
- 3.14. In the event of a bidder having multiple quotes, only the cheapest according to specification will be considered. Furthermore a verification will be done to identify if bidders have multiple companies and are quoting (cover-quoting) for this bid. In such instances only the cheapest bid according to specification will be considered.

**4. SPECIAL INSTRUCTIONS AND NOTICES TO BIDDERS REGARDING THE COMPLETION OF THIS QUOTATION.**

- 4.1. Unless inconsistent with or expressly indicated otherwise by the context, the singular shall include the plural and vice versa and with words importing the masculine gender shall include the feminine and the neuter.
- 4.2. Under no circumstances whatsoever may the quotation/bid forms be retyped or redrafted. Photocopies of the original bid documentation may be used, but an original signature must appear on such photocopies.
- 4.3. The bidder is advised to check the number of pages and to satisfy himself that none are missing or duplicated.
- 4.4. Quotation submitted must be complete in all respects.
- 4.5. Any alteration made by the bidder must be initialled.
- 4.6. Use of correcting fluid is prohibited
- 4.7. Quotation will be opened in public as soon as practicable after the closing time of quotation.
- 4.8. Where practical, prices are made public at the time of opening quotations.
- 4.9. If it is desired to make more than one offer against any individual item, such offers should be given on a photocopy of the page in question. Clear indication thereof must be stated on the schedules attached.

**5. SPECIAL INSTRUCTIONS REGARDING HAND DELIVERED QUOTATIONS**

- 5.1. Quotation shall be lodged at the address indicated not later than the closing time specified for their receipt, and in accordance with the directives in the quotation documents.
- 5.2. Each quotation shall be addressed in accordance with the directives in the quotation documents and shall be lodged in a separate sealed envelope, with the name and address of the bidder, the quotation number and closing date indicated on the envelope. The envelope shall not contain documents relating to any quotation other than that shown on the envelope. If this provision is not complied with, such quotations/bids may be rejected as being invalid.
- 5.3. All quotations received in sealed envelopes with the relevant quotation numbers on the envelopes are kept unopened in safe custody until the closing time of the quotation/bids. Where, however, a quotation is received open, it shall be sealed. If it is received without a quotation/bid number on the envelope, it shall be opened, the quotation number ascertained, the envelope sealed and the quotation number written on the envelope.
- 5.4. A specific box is provided for the receipt of quotations, and no quotation found in any other box or elsewhere subsequent to the closing date and time of quotation will be considered.

- 5.5. No quotation/bid sent through the post will be considered if it is received after the closing date and time stipulated in the quotation documentation, and proof of posting will not be accepted as proof of delivery.
- 5.6. Quotation documents must not be included in packages containing samples. Such quotations may be rejected as being invalid.

**6. SAMPLES**

- 6.1. In the case of the quote document stipulating that samples are required, the supplier will be informed in due course when samples should be provided to the institution. (This decreases the time of safety and storage risk that may be incurred by the respective institution). The bidders sample will be retained if such bidder wins the contract.
  - (i) If a company/s who has not won the quote requires their samples, they must advise the institution in writing of such.
  - (ii) If samples are not collected within three months of close of quote the institution reserves the right to dispose of them at their discretion.
- 6.2. **Samples must be made available when requested in writing or if stipulated on the document.**
  - (i) If a Bidder fails to provide a sample of their product on offer for scrutiny against the set specification when requested, their offer will be rejected. All testing will be for the account of the bidder.

**7. COMPULSORY SITE INSPECTION / BRIEFING SESSION**

7.1. Bidders who fail to attend the compulsory meeting will be disqualified from the evaluation process.

- (i) The institution has determined that a compulsory site meeting  take place
- (ii) Date  /  /  Time  :  Place

Institution Stamp:	Institution Site Inspection / briefing session Official  Full Name: .....  Signature: .....  Date: .....
--------------------	--

**8. STATEMENT OF SUPPLIES AND SERVICES**

8.1. The contractor shall, when requested to do so, furnish particulars of supplies delivered or services executed. If he/she fails to do so, the Department may, without prejudice to any other rights which it may have, institute inquiries at the expense of the contractor to obtain the required particulars.

**9. SUBMISSION AND COMPLETION OF SBD 6.1**

9.1. Should a bidder wish to qualify for preference points they must complete a SBD 6.1 document. Failure by a bidder to provide all relevant information required, will result in such a bidder not being considered for preference points allocation. The preferences applicable on the closing date will be utilized. Any changes after the closing date will not be considered for that particular quote.

**10. TAX COMPLIANCE REQUIREMENTS**

- 10.1. In the event that the tax compliance status has failed on CSD, **it is the suppliers' responsibility to provide a SARS pin in order for the institution to validate the tax compliance status of the supplier.**
- 10.2. In the event that the institution cannot validate the suppliers' tax clearance on SARS as well as the Central Suppliers Database, **the quote will not be considered and passed over as non-compliant according to National Treasury Instruction Note 4 (a) 2016/17.**

**11. TAX INVOICE**

11.1. A tax invoice shall be in the currency of the Republic of South Africa and shall contain the following particulars:

- (i) the name, address and registration number of the supplier;
- (ii) the name and address of the recipient;
- (iii) an individual serialized number and the date upon which the tax invoice is issued;
- (iv) a description and quantity or volume of the goods or services supplied;
- (v) the official department order number issued to the supplier;
- (vi) the value of the supply, the amount of tax charged;
- (vii) the words tax invoice in a prominent place.

**12. PATENT RIGHTS**

The supplier shall indemnify the **KZN Department of Health** (here after known as the purchaser) against all third-party claims of infringement of patent, trademark, or industrial design rights arising from use of the goods or any part thereof by the purchaser.

### **13. PENALTIES**

- 13.1. If at any time during the contract period, the service provider is unable to perform in a timely manner, the service provider must notify the institution in writing/email of the cause of and the duration of the delay. Upon receipt of the notification, the institution should evaluate the circumstances and, if deemed necessary, the institution may extend the service provider's time for performance.
- 13.2. In the event of delayed performance that extends beyond the delivery period, the institution is entitled to purchase commodities of a similar quantity and quality as a substitution for the outstanding commodities, without terminating the contract, as well as return commodities delivered at a later stage at the service provider's expense.
- 13.3. Alternatively, the institution may elect to terminate the contract and procure the necessary commodities in order to complete the contract. In the event that the contract is terminated the institution may claim damages from the service provider in the form of a penalty. The service provider's performance should be captured on the service provider database in order to determine whether or not the service provider should be awarded any contracts in the future.
- 13.4. If the supplier fails to deliver any or all of the goods or to perform the services within the period(s) specified in the contract, the purchaser shall, without prejudice to its other remedies under the contract, deduct from the contract price, as a penalty, a sum calculated on the delivered price of the delayed goods or unperformed services using the current prime interest rate calculated for each day of the delay until actual delivery or performance.

### **14. TERMINATION FOR DEFAULT**

- 14.1. The purchaser, without prejudice to any other remedy for breach of contract, by written notice of default sent to the supplier, may terminate this contract in whole or in part:
  - (i) if the supplier fails to deliver any or all of the goods within the period(s) specified in the contract,
  - (ii) if the supplier fails to perform any other obligation(s) under the contract; or
  - (iii) if the supplier, in the judgment of the purchaser, has engaged in corrupt or fraudulent practices in competing for or in executing the contract.
- 14.2. In the event the purchaser terminates the contract in whole or in part, the purchaser may procure, upon such terms and in such manner as it deems appropriate, goods, works or services similar to those undelivered, and the supplier shall be liable to the purchaser for any excess costs for such similar goods, works or services.
- 14.3. Where the purchaser terminates the contract in whole or in part, the purchaser may decide to impose a restriction penalty on the supplier by prohibiting such supplier from doing business with the public sector for a period not exceeding 10 years.

### **15. FAILURE TO COMPLY WITH ABOVE WILL RESULT IN YOUR QUOTE BEING PASSED OVER.**



**PREFERENCE POINTS CLAIM FORM IN TERMS OF THE PREFERENTIAL PROCUREMENT REGULATIONS 2017**

This preference form must form part of all quotes invited. It contains general information and serves as a claim form for preference points for Broad-Based Black Economic Empowerment (B-BBEE) Status Level of Contribution

**NB: BEFORE COMPLETING THIS FORM, BIDDERS MUST STUDY THE GENERAL CONDITIONS, DEFINITIONS AND DIRECTIVES APPLICABLE IN RESPECT OF B-BBEE, AS PRESCRIBED IN THE PREFERENTIAL PROCUREMENT REGULATIONS, 2017.**

**1. GENERAL CONDITIONS**

1.1 The following preference point systems are applicable to all quotes:

- the 80/20 system for requirements with a Rand value of up to R50 000 000 (all applicable taxes included); and

1.2 The value of this quote is estimated to not exceed R50 000 000 (all applicable taxes included) and therefore the 80/20 preference point system shall be applicable.

1.3 Points for this quote shall be awarded for:

- (a) Price; and
- (b) B-BBEE Status Level of Contributor.

1.4 The maximum points for this quote is allocated as follows:

	<b>POINTS</b>
<b>PRICE</b>	80
<b>B-BBEE STATUS LEVEL OF CONTRIBUTOR</b>	20
<b>Total points for Price and B-BBEE must not exceed</b>	<b>100</b>

1.5 Failure on the part of a bidder to submit proof of B-BBEE Status level of contributor together with the quote, will be interpreted to mean that preference points for B-BBEE status level of contribution are not claimed.

1.6 The purchaser reserves the right to require of a bidder, either before a quote is adjudicated or at any time subsequently, to substantiate any claim in regard to preferences, in any manner required by the purchaser.

**2. DEFINITIONS**

- (a) **"B-BBEE"** means broad-based black economic empowerment as defined in section 1 of the Broad-Based Black Economic Empowerment Act;
- (b) **"B-BBEE status level of contributor"** means the B-BBEE status of an entity in terms of a code of good practice on black economic empowerment, issued in terms of section 9(1) of the Broad-Based Black Economic Empowerment Act;
- (c) **"bid"** means a written offer in a prescribed or stipulated form in response to an invitation by an organ of state for the provision of goods or services, through price quotations, advertised competitive bidding processes or proposals;
- (d) **"Broad-Based Black Economic Empowerment Act"** means the Broad-Based Black Economic Empowerment Act, 2003 (Act No. 53 of 2003);
- (e) **"EME"** means an Exempted Micro Enterprise in terms of a code of good practice on black economic empowerment issued in terms of section 9 (1) of the Broad-Based Black Economic Empowerment Act;
- (f) **"functionality"** means the ability of a tenderer to provide goods or services in accordance with specifications as set out in the tender documents.
- (g) **"prices"** includes all applicable taxes less all unconditional discounts;
- (h) **"proof of B-BBEE status level of contributor"** means:
  - 1) B-BBEE Status level certificate issued by an authorized body or person;
  - 2) A sworn affidavit as prescribed by the B-BBEE Codes of Good Practice;
  - 3) Any other requirement prescribed in terms of the B-BBEE Act;
- (i) **"QSE"** means a qualifying small business enterprise in terms of a code of good practice on black economic empowerment issued in terms of section 9 (1) of the Broad-Based Black Economic Empowerment Act;
- (j) **"rand value"** means the total estimated value of a contract in Rand, calculated at the time of bid invitation, and includes all applicable taxes;

**3. POINTS AWARDED FOR PRICE**

**3.1 THE 80/20 PREFERENCE POINT SYSTEMS**

A maximum of 80 points is allocated for price on the following basis:

$$P_s = 80 \left( 1 - \frac{P_t - P_{\min}}{P_{\min}} \right) \text{ Where}$$

- Ps = Points scored for price of bid under consideration
- Pt = Price of bid under consideration
- Pmin = Price of lowest acceptable bid

**4. POINTS AWARDED FOR B-BBEE STATUS LEVEL OF CONTRIBUTOR**

4.1 In terms of Regulation 6 (2) and 7 (2) of the Preferential Procurement Regulations, preference points must be awarded to a bidder for attaining the B-BBEE status level of contribution in accordance with the table below:

B-BBEE Status Level of Contributor	Number of points (80/20 system)
1	20
2	18
3	14
4	12
5	8
6	6
7	4
8	2
Non-compliant contributor	0

**5. BID DECLARATION**

5.1 Bidders who claim points in respect of B-BBEE Status Level of Contribution must complete the following:

**6. B-BBEE STATUS LEVEL OF CONTRIBUTOR CLAIMED IN TERMS OF PARAGRAPHS 1.4 AND 4.1**

6.1 B-BBEE Status Level of Contributor: = .....(maximum of 20 points)

(Points claimed in respect of paragraph 7.1 must be in accordance with the table reflected in paragraph 4.1 and must be substantiated by relevant proof of B-BBEE status level of contributor.)

**7. SUB-CONTRACTING**

(Tick applicable box)

7.1 Will any portion of the contract be sub-contracted?

YES	<input type="checkbox"/>	NO	<input type="checkbox"/>
-----	--------------------------	----	--------------------------

7.1.1 If yes, indicate:

- i) What percentage of the contract will be subcontracted.....%
- ii) The name of the sub-contractor.....
- iii) The B-BBEE status level of the sub-contractor.....

8. Whether the sub-contractor is an EME or QSE

(Tick applicable box)

iv) Specify, by ticking the appropriate box, if subcontracting with an enterprise in terms of Preferential Procurement Regulations, 2017:

YES	<input type="checkbox"/>	NO	<input type="checkbox"/>
-----	--------------------------	----	--------------------------

Designated Group: An EME or QSE which is at last 51% owned by:	EME	QSE
	√	√
Black people		
Black people who are youth		
Black people who are women		
Black people with disabilities		
Black people living in rural or underdeveloped areas or townships		
Cooperative owned by black people		
Black people who are military veterans		
OR		
Any EME		
Any QSE		

9. **DECLARATION WITH REGARD TO COMPANY/FIRM**

9.1 Name of company/firm:.....

9.2 VAT registration number:.....

9.3 Company registration number:.....

9.4 **TYPE OF COMPANY/ FIRM [TICK APPLICABLE BOX]**

- Partnership/Joint Venture / Consortium
- One person business/sole propriety
- Close corporation
- Company
- (Pty) Limited

9.5 **DESCRIBE PRINCIPAL BUSINESS ACTIVITIES**

.....  
.....

9.6 **COMPANY CLASSIFICATION [TICK APPLICABLE BOX]**

- Manufacturer
- Supplier
- Professional service provider
- Other service providers, e.g. transporter, etc.

9.7 Total number of years the company/firm has been in business:.....

9.8 I/we, the undersigned, who is / are duly authorised to do so on behalf of the company/firm, certify that the points claimed, based on the B-BBE status level of contributor indicated in paragraphs 1.4 and 6.1 of the foregoing certificate, qualifies the company/ firm for the preference(s) shown and I / we acknowledge that:

- i) The information furnished is true and correct;
- ii) The preference points claimed are in accordance with the General Conditions as indicated in paragraph 1 of this form;
- iii) In the event of a contract being awarded as a result of points claimed as shown in paragraphs 1.4 and 6.1, the contractor may be required to furnish documentary proof to the satisfaction of the purchaser that the claims are correct;
- iv) If the B-BBEE status level of contributor has been claimed or obtained on a fraudulent basis or any of the conditions of contract have not been fulfilled, the purchaser may, in addition to any other remedy it may have –
  - (a) disqualify the person from the bidding process;
  - (b) recover costs, losses or damages it has incurred or suffered as a result of that person's conduct;
  - (c) cancel the contract and claim any damages which it has suffered as a result of having to make less favourable arrangements due to such cancellation;
  - (d) recommend that the bidder or contractor, its shareholders and directors, or only the shareholders and directors who acted on a fraudulent basis, be restricted by the National Treasury from obtaining business from any organ of state for a period not exceeding 10 years, after the *audi alteram partem* (hear the other side) rule has been applied; and
  - (e) forward the matter for criminal prosecution.

<p><b>WITNESSES</b></p> <p>1. ....</p> <p>2. ....</p>
---

<p>.....</p> <p><b>SIGNATURE(S) OF BIDDERS(S)</b></p> <p><b>DATE:</b> .....</p> <p><b>ADDRESS</b>.....</p> <p>.....</p> <p>.....</p>
--



**PROVINCE OF KWAZULU-NATAL**

**DEPARTMENT OF HEALTH**

**Supply and install mechanical ventilation at Madadeni gate  
way clinic**

**MADADENI HOSPITAL**

**ZNQ NO:** \_\_\_\_\_

**Closing Date & Time** : @ 11h00  
**Contract Period** : 1 Week  
**Validity Period** : 60 Days  
**Technical Contact Person** : MR. SV Mbatha  
**Contact Telephone Number** : 034 328 8201  
**On Site Inspection** :

**WORK DISCIPLINE: CIDB (SO,GB)**

This is a multi-disciplinary Contract and Contractors should only tender for services in respect of their own area/s of expertise. The Tenderer shall in the Schedule of Information, and by way of supplementary information, satisfy the Head of Department or his or her designee that sufficient equipment is possessed to execute the services, or an indication shall be given as to the manner in which such equipment would be sourced. Should the Tenderer not be able to prove possession of, or ability to access, sufficient equipment, the Tender will be wholly disqualified. The Head of Department or his or her designee reserves the right to investigate the existence and/or proposed sourcing of equipment.

The Tenderer also will be required to satisfy the Head of Department or his or her designee that a sufficient/qualified and experienced labour force is employed, or that sufficient

experienced labour can be acquired, to complete the services and produce a fair quality of workmanship. The Tenderer will be required to produce adequate and sufficient references to enable the Head of Department or his or her designee to inspect previously completed work and assess the capacity of the Tenderer.

The Head of Department or his or her designee reserves the right to recommend that Tenderers execute work of only certain types and up to certain capacities due to the limitations of experience and skills of the Tenderer. Any limitations to such work tendered for will be recommended to the Central Procurement Committee for approval and will be applied strictly during the contract period.

The successful Tenderer shall supply all materials, labour, tools and plant etc., necessary to carry out maintenance, repairs, servicing, upgrading, replacement, and minor new works to buildings.

**Contractor .....**  
**Madadeni gateway clinic**

PROVINCE OF KWAZULU-NATAL  
DEPARTMENT OF HEALTH

**Supply and install mechanical ventilation at Madadeni gate  
way clinic**

**MADADENI HOSPITAL**

**ZNQ NO: \_\_\_\_\_**

**PROJECT SPECIFICATIONS**

**1. NOTES TO TENDERERS**

**1.1. SCOPE OF CONTRACT**

This Contract is for the complete execution of the project indicated above.

**1.2. CONDITIONS OF CONTRACT AND PRELIMINARIES**

**1.2.1 PERIOD OF CONTRACT**

**01Week** as the Contract Period for the completion of *all Works* from date of Site handover.

**1.2.2 CONTRACT GUARANTEE:**

The successful Tenderer will **NOT** be required to submit a contract guarantee.

**1.2.3 GUARANTEE PERIOD**

The guarantee period for *all Works* and all materials must be for a minimum of **One (1) Year** from the date of first delivery. UNLES SPECIFIED

**1.2.4 SITE AND MODE OF PROCEDURE**

The work contained in this contract will be carried out on the site of the existing Institution.

The Contractor is advised that the existing premises will be occupied throughout the period of the contract.

Damage to existing buildings - Tenderers to note that any damages done or occurring to any of the buildings will be repaired at the expense of the contractor/ Tenderer.

Contractor .....  
Madadeni gateway clinic

The repairs must be to the satisfaction of the KwaZulu- Natal Department of Health.

**1.2.5 SATISFACTORY INSTALLATION**

The whole of the installation shall be carried out in accordance with the South African Bureau of Standards Code of Practice for the application of National Building Regulations, the KZNPA Standard Preambles to all Trades, REGULATION R158, the KZNPA General Electrical Specification, the South African Bureau of Standards Code of Practice for the Wiring of Premises 0142-1 and the Occupational Health and Safety Act 85 of 1993 as amended.

Copies of the KZNPA Standard Preambles to all Trades and the KZNPA General Electrical Specification are available at the office of the Secretary for Health – KwaZulu-Natal and can be obtained on request. Also on the website-KZNHEALTH

**1.2.6 CERTIFICATE OF COMPLIANCE**

**NB: COC will be required for any electrical work done**

**CODES AND SPECIFICATIONS FOR ELECTRICAL INSTALLATIONS**

The complete installation shall conform to the following:

The South African National Standards Wiring Code - SANS 10142-1:2006.

Occupational Health and Safety Act and Regulations (85 of 1993).

Energy Code of Conduct for all Government Buildings Rev 3

The Local Authority Fire Regulations.

ICASA Regulations.

National Building Regulations and the SANS 10400: Code of Practice for the Application of the

National Building Regulations.

R158 where applicable

1.2.7 **Health and safety act 85(1993)**

## **MADADENI HOSPITAL CONTRACTOR'S HEALTH & SAFETY REQUIREMENTS**

### **INTRODUCTION**

- Contractors on site, within MADADENI HOSPITAL are obliged to abide with all Health and Safety Policy and other applicable Safety, Health and Environmental legal requirements in order to promote safe working environment for all.

### **PURPOSE OF THESE REQUIREMENTS**

- The purpose is to describe how to effectively manage, minimize and or where practical possible eliminate risk and environmental pollution or contamination resulting from construction work undertaken by external contractors on behalf of King Edward VIII Hospital.

### **THE CONTRACTOR MUST:**

- Comply with the conditions outlined in the procedure written under Contractors Management Policy of Madadeni Hospital.
- Furnish the client with all the required documents prior commencing with civil work or any work on site.
- Report all occurrences to the Maintenance Manager and Health and Safety Department.
- Ensure that their employees have been inducted before commencement of work and evidence must be available.
- Register at Security Department for every business visit and for breakdown callouts.
- Ensure that all employees of contractors undertaking work in Madadeni premises have identity cards.
- Provide a list of all tools in their possession at all times on entry and exit and any changes must be made at Security on entry.

## **HEALTH AND SAFETY DOCUMENTS/FILE**

Required legal documents to be submitted by the appointed contractor prior commencing with the project / work, must include but not limited to the following documents:

1. Signed Section 37 (2) Agreement.
2. SHE Policy
3. Safety, Health and Environmental Management Plan; if applicable this must also include Waste Management plan.
4. Risk Assessment.
5. Scope/ Specification of work.
6. Staff Organogram
7. Legal appointment letters together with competency certificates.
8. Health and Safety Committee
9. A valid Letter of Good Standing (COID) from Department of Labour.
10. List of equipments to be utilized and PPE register
11. Inspection checklists
12. Toolbox/safety talks Performa
13. Incident management
14. Emergency Planning
15. Training records of workers where practical applicable and attendance registers.
16. Appointed contractor must ensure that all legal documentation as outlined in Construction Regulation in terms of Occupational Health and Safety Act are developed and submitted to the client and kept on site for ease of reference at all times.
17. All occurrences/incidents/accidents to be reported to Health and Safety Department and recorded on the incident register as when incidents occur.
18. Monitoring or performance measurement shall be conducted on regular bases to evaluate the level of compliance to applicable SHE legislation and Project SHE specification.

### **MINIMUM REQUIREMENTS OF PPE:**

In terms of the General Safety Regulations, regulation 2; the following minimum PPE must be adhered to at all times when carrying out any construction activity.

- Hard hat;
- Safety boots;
- Reflective vests; and
- Other suitable PPE for proposed activities.

### **SAFETY SIGNS AND DEMARCATION OF WORK AREAS**

- Obey all Institutional signs and contractors to put back any sign removed during maintenance or installation.
- Every contractor must put up a demarcation tape / barrier net with signs indicating workman overhead or hazard falling object.



#### **UNDERTAKING OF HAZARDOUS WORK**

- Contractor must obtain permission from the Maintenance Manager or his duly representative and a written detailed description of the work with safety precautions must be submitted for approval before work is undertaken.
- Contractor must bring in specialist subcontractors for hazardous work and work to be co-ordinated with the Hospital Engineer or his duly representative.

#### **LOCKING OUT OR ISOLATION OF MACHINERY**

- Contractor to request for permission in writing for any shut down of plants from the Maintenance Manager or his duly representative and the request must be at least seven working days in advance. Contractor to clearly indicate work to be done.

#### **CARRYING OUT OF HOT WORK ON SITE**

- Contractor to make sure that the Hospital hot work procedure is adhered to and completed permits are returned to authorised person at the end of each shift.
- Work area to be inspected for combustibles before work and inspected again on work completion.
- Contractor to make sure that all employees carrying out hot work have been trained and can effectively use fire fighting equipment according to classes of fire.
- Welding screen/appropriate PPE must be provided in public areas and area to be demarcated.

#### **HOUSEKEEPING ON SITE**

- Contractors must make sure that daily cleaning and effective removal of rubble is undertaken to the satisfaction of the Hospital Management.
- Contractor to hire own bins as required.

#### **ACCESS TO WARDS AND OTHER HEALTHCARE AREAS**

- Contractor to make sure that prior arrangement for access to a Ward has been made before hand with the relevant section **Artisan Foreman/Project Manager**.
- Contractors to request Security personnel to escort during weekends and public holidays.

#### **THEFT AND PROPERTY DAMAGE REPORTING**

- Contractor to immediately report theft and damage to their own or Hospital property to Security Dept. and fill in forms with sworn statements.
- Contractor to co-operate with security personnel should they be required to stand in as witness in theft or damage.

#### **DISASTER MANAGEMENT**

- Contractor to follow all instructions and assist as requested in case of a disaster.
- Contractor to notify switchboard as soon as a disaster has been declared and also contact the relevant Project Manager.

**ERECTED SCAFFOLD FRAMEWORK AND PLATFORM AND SUSPENDED SCAFFOLD.**

- Contractor to ensure that scaffold framework and platforms are constructed as per General Safety Regulation 13(D) (1)-(3) and 13 (E) (1) - (4) respectively.
- Suspended scaffolds must comply with General Safety Regulation 13(F) (1)-(4).

**STORAGE OF FLAMMABLE MATERIALS**

- Contractor to ensure that all flammable liquids are stored in lockable room, cabinet or enclosure and clearly marked on the outside.
- Permanent or temporal storage facilities must have intake and exhaust ventilation.
- Contractors to undertake all reasonable precautionary measures to prevent fumes or vapours from spreading to other areas during use or storage.

**ELECTRICAL CABLING INCLUDING NETWORKS CABLING**

- No bare cabling is allowed on ceiling trays and supports.
- All cabling must be in trunking or tubing as per SABS wiring Code 0142 and per Facilities Management wiring and cabling specification, which is available on request.
- No cabling must run in the plumbing ducts and cable trays must be installed where applicable.

**OTHER REQUIREMENTS FOR CONTRACTORS**

- All contractors are not allowed to park their vehicles in staff parking bays and on no parking zones.
- Contractors to request for permission from institutional management via Maintenance Manager or his duly authorised person to block off access routes during deliveries or other dangerous operations and this must be at least seven days in advance.
- Contractors must ensure that every tool brought or being used in or on the premises must comply with OHS Act standards and contractors will be asked to remove or urgently sort out tools or equipments found to be unsafe or below set of standards. The Maintenance Manager or his duly authorised person would randomly inspect tools and equipments.
- Contractors to provide their employees with personal protective clothing and equipment as required by the OHS Act.
- Contractors must be aware that no Hospital equipment, tools, spares and etc. must be used without prior authority from Hospital Management via Hospital Engineer or his duly authorised person.
- Hospital is not obligated to provide a storage area for contractors working on site, arrangement can be made if there is available area in negotiation with the Hospital Manager or his duly appointed representatives.
- Contractors must be aware that any damage to Government property caused through negligence would be rectified at the contractor's expense.
- Contractors using Madadeni Hospital ablution facilities must make sure that these are kept clean and report all faults to Security or relevant Section Foreman or the Maintenance Manager.

**Contractor .....**  
**Madadeni gateway clinic**

- Contractors must not use water from fire hose reels for washing floors, mixing of building or plastering mud and filling of water tanks.
- No machinery must be operated without machine guarding.
- No work is permitted on moving machinery.
- Contractors to make sure that all manholes are open and locked out before entering a confined space.
- No firearms allowed into the premises and these must be handed to Security for safe keeping and collected upon exit.
- Consumption of alcohol or intoxicating substance is not allowed inside the premises.
- All asbestos work must be carried out in terms of Asbestos Regulations 2001.

**Note**

**Proper signage must be displayed and fixed barricading done**

PROVINCE OF KWAZULU-NATAL  
DEPARTMENT OF HEALTH

Supply and install mechanical ventilation at Madadeni gateway clinic

MADADENI HOSPITAL  
ZNQ NO: \_\_\_\_\_

TECHNICAL SPECIFICATIONS

2. TECHNICAL SPECIFICATION

2.1 GENERAL

This TECHNICAL SPECIFICATION shall be read in conjunction with all other sections of the SPECIFICATION and cognisance shall be taken of the clauses relevant to this particular installation, whether any specific clauses are referred to or not.

Specifications

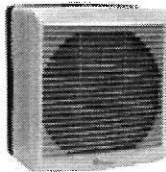

Xpelair GX 12 window / surface wall

Hole diameter:

- 324mm dia. if used with ladder strips.
- 330mm dia. if used with WK12/11 wall kit.

Dimensions

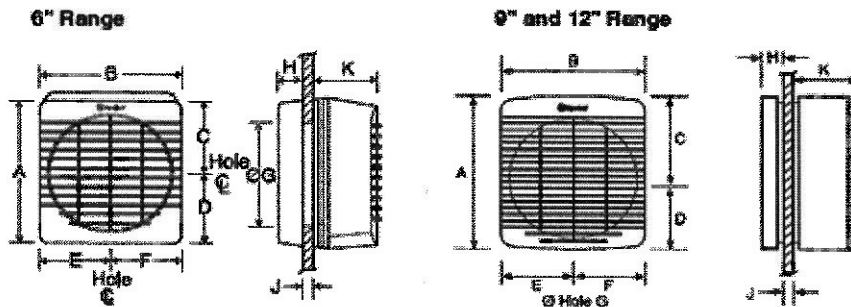

Dimensions (mm)	
Model	A B C D E F G H J K
6"	226 210 119 107 109 101 184/203 32 4-25 112
9"	312 294 165 147 147 147 257/266 32 4-25 117
12"	408 380 216 192 190 190 324/330 34 4-25 161

Contractor .....  
Madadeni gateway clinic

### Installation and Accessories

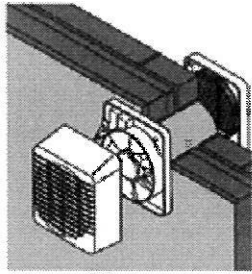

6"  
Wall Mounting

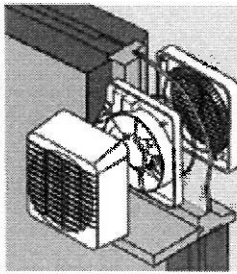

6"  
Window Mounting

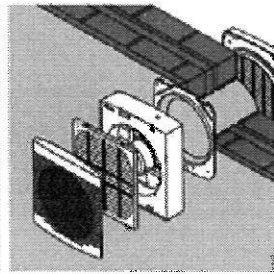

9" & 12"  
Wall Mounting

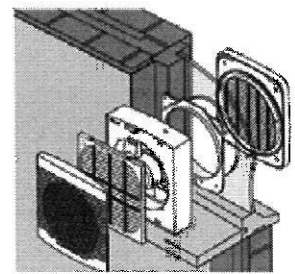

9" & 12"  
Window Mounting

Xpelair GX 12 window / surface wall

Fan – 300mm Dia with auto shutter

Model GX 12 90012 AW

30amps breaker

30amps isolator

Fan controller

GX12

- Variable speed use with EC6.
- 2 Speed if used with FR22/30 controller.
- Connect to light switch or separate On/Off switch.
- Intake & extract.
- Automatic shutter

## Scope of works

1. Supply and install the extractor fans as per the given specifications
2. Supply and install the electrical installations and issue COC

**SCHEDULE OF RATES**

**WORK TO BE DONE AT MADADENI HOSPITAL AND SCHEDULE OF PRICES:**

Item	DESCRIPTION	UNIT	QTY	RATE/UNIT		TOTAL	
				R	c	R	c
	<b><u>INSTITUTION:Madadeni gate wayclinic</u></b> <b><u>ZNQ NO:</u></b> All rates quoted shall be inclusive of transport, Labour and profit. The Tenderer is advised that the buildings are occupied						
	<b><u>PROPRIETARY ARTICLES:</u></b> All equipment and material used in this contract shall be that which is specified or other SABS approved.						
1.	Supply and install the extractor fans as per the given specifications	Units	08				
2.	Supply and install the electrical installations from the supply and issue COC	Item					
3.							
<b>CARRIED TO COLLECTION SUMMARY PS 1</b>				<b>TOTAL</b>			

Contractor .....  
 Madadeni gateway clinic

# COLLECTION SUMMARY

**PROJECT**  
**DESCRIPTION:**

**Supply and install mechanical ventilation  
at Madadeni gate way clinic**

**ZNQ NO: \_\_\_\_\_**

**NOTE:**

THIS COLLECTION SUMMARY MUST BE COMPLETED IN FULL BY THE CONTRACTOR AND RETURNED TOGETHER WITH THE QUOTATION FORM.

Collection Summary PS 1	R	
Safety requirements	R	
Sub total	R	

  
\_\_\_\_\_  
Mr. SV Mbatha  
Chief Artisan

22/07/2021  
Date

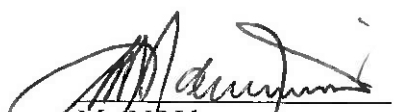
  
\_\_\_\_\_  
Mr. N Ndamane  
Deputy Director Systems

22/07/2021  
Date

\_\_\_\_\_  
Mr C Zwane  
Assistant Director SCM

\_\_\_\_\_  
Date

\_\_\_\_\_  
Company Director/ Company name

Contractor .....  
Madadeni gateway clinic

MADADENI HOSPITAL  
**Maintenance**  
Project Policy

**Supply and install mechanical ventilation at Madadeni gate way clinic**

1. Proof of work force
2. Detailed work plan-it must be presented as per days e.g. day1, Day2, Day3 (Service provider must indicate the delivery period on the quotation).
3. Penalties will be applied as per contract special conditions of quotation and will be calculated at 0,04% per day.
4. Presentation of a safety file (It is a must)
5. Proof of references (It is a must)
6. There will be a compulsory project progress meeting between a contractor and DOH (Project leader)

  
\_\_\_\_\_  
Mr. SV Mbatha  
Chief Artisan

22/07/2021  
Date

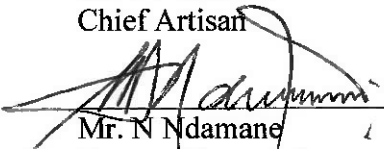
  
\_\_\_\_\_  
Mr. N Ndamane  
Deputy Director Systems

22/07/2021  
Date

\_\_\_\_\_  
Mr T Zwane  
Assistant Director SCM

\_\_\_\_\_  
Date

\_\_\_\_\_  
Company Director/ Company name



**PROVINCE OF KWAZULU-NATAL  
DEPARTMENT OF HEALTH**

**Supply and install mechanical ventilation at Madadeni gate  
way clinic**

**ZNQ NO: \_\_\_\_\_**

**SCHEDULE OF RATES**

**3.1 ITEMS AND PRICING**

The Department reserves the right to place an order for any quantities of items included in the Schedules. The Schedule of Rates must also not be assumed to include and describe every detail of the supply requirement, but must be taken and read in conjunction with the other parts of the document. Thus the supplier shall not have claim for further payment in respect of any order which may be described or implied in the contract, although apparently no corresponding items are given in the Schedule of Rates. The supplier shall be deemed to have satisfied himself before quoting as to the correctness and sufficiency of his quote for the contract and of the rates and prices stated in the Schedule of Rates.

**3.2 TAX AND DUTIES**

Prices, quoted and paid, must include all customs, excise and import duties, and any other tariffs or taxes levied by the government or statutory body having jurisdiction on the goods provided under this contract, including Value Added Tax (applicable to the current rate).

**3.3 RATES**

Except where provision is made in the Schedule of Rates, the rates and prices inserted shall be the full rates and prices for the service delivered described under the respective items and shall cover all labour, transport, overhead charges and profit, etc. as well as the general liabilities, obligations and risks arising out of the Conditions of Contract, the overhead charges and profit being spread proportionately over the rates of the relative items in the Schedule of Rates.

**SCHEDULE OF REFERENCES**

References of previous work completed for the department of health or other to be listed below.

PLACE WORK WAS DONE	CONTACT PERSON	PHONE NUMBER	JOB COMPLETED

**NB. If this is not filled, your document will not be evaluated.**

**SIGNATURE OF TENDERER:.....**

**DATE: .....**

**Contractor .....  
Madadeni gateway clinic**