

SharePoint

Nkosi Nomasonto ▾ ?



## KZN Health Intranet

KZN HEALTH

Search this site

HOME CORPORATE INFORMATION COMPONENTS DIRECTORY DISTRICT OFFICES HEALTH FACILITIES

KZN Health > Components > Supply Chain Management

AdvertQuote



### Quotation Advert

Opening Date: 2021-11-23

Closing Date: 2021-12-08

Closing Time: 11:00

#### INSTITUTION DETAILS

Institution Name: Dundee hospital

Province: KwaZulu-Natal

Department or Entity: Department of Health

Division or section: Central Supply Chain Management

Place where goods / services is required: Dundee Hospital

Date Submitted: 2021-11-29

#### ITEM CATEGORY AND DETAILS

Quotation Number: ZNQ:  
DDE/00387/21-22

Item Category: .Goods

Item Description: SUPPLY AND DELIVER:  
MAINTANANCE MATERIAL

Quantity (if supplies): AS PER ATTACHED LIST

#### COMPULSORY BRIEFING SESSION / SITE VISIT

Select Type: Not Applicable

Date:

Time:

Venue:

QUOTES CAN BE COLLECTED FROM: KZN HEALTHWEB SITE

QUOTES SHOULD BE DELIVERED TO: 121 MCKENZIE STREET DUNDEE 3000

#### ENQUIRIES REGARDING THE ADVERT MAY BE DIRECTED TO:

Name: NOMASONTO NKOSI

Email: nomasonto.nkosi@kznhealth.gov.za

Contact Number: 034 218 1245

Finance Manager Name:

MS N.P. ZULU

Finance Manager Signature:

No late quotes will be considered

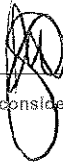

STANDARD QUOTE DOCUMENTATION OVER R30 000.00

YOU ARE HEREBY INVITED TO QUOTE FOR REQUIREMENTS AT: DUNDEE HOSPITAL
DATE ADVERTISED: 30/11/2021 CLOSING DATE: 08/12/2021 CLOSING TIME: 11:00
FACSIMILE NUMBER: 034 212 3245 E-MAIL ADDRESS: quotes.dundeeHospital@kznhealth.gov.za
PHYSICAL ADDRESS: 121 MCKENZIE STREET DUNDEE 3000

QUOTE NUMBER: DDE/00387/21-22
DESCRIPTION: MAINTANANCE MATERIAL
CONTRACT PERIOD: ONCE OFF (if applicable) VALIDITY PERIOD 60 Days SARS PIN:

CENTRAL SUPPLIER DATABASE REGISTRATION (CSD) NO. [Grid]

UNIQUE REGISTRATION REFERENCE [Grid]

DEPOSITED IN THE QUOTE BOX SITUATED AT (STREET ADDRESS)
121 MCKENZIE STREET
DUNDEE HOSPITAL

Bidders should ensure that quotes are delivered timeously to the correct address. If the quote is late, it will not be accepted for consideration.

The quote box is open from 08:00 to 15:30.

QUOTATIONS MUST BE SUBMITTED ON THE OFFICIAL FORMS – (NOT TO BE RETYPED)

THIS QUOTE IS SUBJECT TO THE PREFERENTIAL PROCUREMENT POLICY FRAMEWORK ACT AND THE PREFERENTIAL PROCUREMENT REGULATIONS, 2011, THE GENERAL CONDITIONS OF CONTRACT (GCC) AND, IF APPLICABLE, ANY OTHER SPECIAL CONDITIONS OF CONTRACT.

THE FOLLOWING PARTICULARS MUST BE FURNISHED (FAILURE TO DO SO MAY RESULT IN YOUR QUOTE BEING DISQUALIFIED)

NAME OF BIDDER
POSTAL ADDRESS
STREET ADDRESS
TELEPHONE NUMBER CODE.....NUMBER..... FACSIMILE NUMBER CODE.....NUMBER.....
CELLPHONE NUMBER
E-MAIL ADDRESS
VAT REGISTRATION NUMBER (If VAT vendor)

HAS A B-BBEE STATUS LEVEL VERIFICATION CERTIFICATE BEEN SUBMITTED? (SBD 6.1) [YES] [NO]
[A B-BBEE STATUS LEVEL VERIFICATION CERTIFICATE/SWORN AFFIDAVIT (FOR EMEs& QSEs) MUST BE SUBMITTED TO QUALIFY FOR PREFERENCE POINTS FOR B-BBEE]

DECLARATION OF INTEREST

1. Any legal person, including persons employed by the state<sup>1</sup>, or persons having a kinship with persons employed by the state, including a blood relationship, may make an offer or offers in terms of this invitation to quote (includes a price quotation, advertised competitive quote, limited quote or proposal). In view of possible allegations of favouritism, should the resulting quote, or part thereof, be awarded to persons employed by the state or to persons connected with or related to them, it is required that the bidder or his/her authorised representative declare his/her position in relation to the evaluating/adjudicating authority where-
  - the bidder is employed by the state; and/or
  - the legal person on whose behalf the bidding document is signed, has a relationship with persons/a person who are/is involved in the evaluation and or adjudication of the quote(s), or where it is known that such a relationship exists between the person or persons for or on whose behalf the declarant acts and persons who are involved with the evaluation and or adjudication of the quote.
2. In order to give effect to the above, the following questionnaire must be completed and submitted with the quote.

- 2.1. Full Name of bidder/representative.....
- 2.2. Identity Number: ..... 2.4. Company Registration Number: .....
- 2.3. Position occupied in the Company (director, trustee, shareholder<sup>2</sup>): ..... 2.5. Tax Reference Number: .....
- 2.6. VAT Registration Number: .....
- 2.7. The names of all directors / trustees / shareholders / members, their individual identity numbers, tax reference numbers and, if applicable, employee / persal numbers must be indicated in paragraph 3 below. [TICK APPLICABLE]
- 2.8. Are you or any person connected with the bidder presently employed by the state? 

YES	NO
-----	----
- 2.8.1. If so, furnish the following particulars:
  - Name of person / director / trustee / shareholder/ member: .....
  - Name of state institution at which you or the person connected to the bidder is employed:.....
  - Position occupied in the state institution: .....Any other particulars:.....
- 2.8.2. If you are presently employed by the state, did you obtain the appropriate authority to undertake remunerative work outside employment in the public sector? 

YES	NO
-----	----
- 2.8.2.1. If yes, did you attach proof of such authority to the quote document?  
*(Note: Failure to submit proof of such authority, where applicable, may result in the disqualification of the quote.)*
- 2.8.2.2. If no, furnish reasons for non-submission of such proof: .....
- 2.9. Did you or your spouse, or any of the company's directors / trustees / shareholders / members or their spouses conduct business with the state in the previous twelve months? 

YES	NO
-----	----
- 2.9.1. If so, furnish particulars:.....
- 2.10. Do you, or any person connected with the bidder, have any relationship (family, friend, other) with a person employed by the state and who may be involved with the evaluation and or adjudication of this quote? 

YES	NO
-----	----
- 2.10.1. If so, furnish particulars:.....
- 2.11. Are you, or any person connected with the bidder, aware of any relationship (family, friend, other) between any other bidder and any person employed by the state who may be involved with the evaluation and or adjudication of this quote? 

YES	NO
-----	----
- 2.11.1. If so, furnish particulars:.....
- 2.12. Do you or any of the directors / trustees / shareholders / members of the company have any interest in any other related companies whether or not they are bidding for this contract? 

YES	NO
-----	----
- 2.12.1. If so, furnish particulars:.....

3. Full details of directors / trustees / members / shareholders.

NB: The Department Of Health will validate details of directors / trustees / members / shareholders on CSD. It is the suppliers' responsibility to ensure that their details are up-to-date and verified on CSD. If the Department cannot validate the information on CSD, the quote will not be considered and passed over as non-compliant according to National Treasury Instruction Note 4 (a) 2016/17.

4 DECLARATION

I, THE UNDERSIGNED (NAME).....CERTIFY THAT THE INFORMATION FURNISHED IN PARAGRAPHS 2.

I ACCEPT THAT THE STATE MAY REJECT THE QUOTE OR ACT AGAINST ME SHOULD THIS DECLARATION PROVE TO BE FALSE.

.....	.....	.....	.....
Name of bidder	Signature	Position	Date

<sup>1</sup>"State" means -

- |   |   |
|---|---|
| <ul style="list-style-type: none"> <li>a) any national or provincial department, national or provincial public entity or constitutional institution within the meaning of the Public Finance Management Act, 1999 (Act No. 1 of 1999);</li> <li>b) any municipality or municipal entity;</li> </ul> | <ul style="list-style-type: none"> <li>c) provincial legislature;</li> <li>d) national Assembly or the national Council of provinces; or</li> <li>e) Parliament.</li> </ul> |
|---|---|

<sup>2</sup>"Shareholder" means a person who owns shares in the company and is actively involved in the management of the enterprise or business and exercises control over the enterprise.

## SPECIAL CONTRACT CONDITIONS OF QUOTATIONS

### 1. AMENDMENT OF CONTRACT

- 1.1. Any amendment to or renunciation of the provisions of the contract shall at all times be done in writing and shall be signed by both parties.

### 2. CHANGE OF ADDRESS

- 2.1. Bidders must advise the Department of Health (institution where the offer was submitted) should their address (*domicilium citandi et executandi*) details change from the time of bidding to the expiry of the contract.

### 3. GENERAL CONDITIONS ATTACHED TO THIS QUOTATION

- 3.1. The Department is under no obligation to accept the lowest or any quote.
- 3.2. The Department reserves the right to communicate in writing with vendors in cases where information is incomplete or where there are obscurities regarding technical aspects of the offer, to obtain confirmation of prices or preference claims in cases where it is evident that a typing, written, transfer or unit error has been made, to investigate the vendor's standing and ability to complete the supply/service satisfactorily.
- 3.3. **ALL DECISIONS TAKEN BY THE DEPARTMENT ARE FINAL, INCLUDING THE AWARD OF THIS QUOTATION.**
- 3.4. The price quoted must include VAT (if VAT vendor). However, it must be noted that the Department reserves the right to evaluate all quotations excluding VAT as some bidders may not be VAT vendors.
- 3.5. The bidder must ensure the correctness & validity of the quotation:
- (i) *that the price(s), rate(s) & preference quoted cover all for the work/item (s) & accept that any mistakes regarding the price (s) & calculations will be at the bidder's risk*
  - (ii) *it is the responsibility of the bidder to confirm receipt of their quotation and to keep proof thereof.*
- 3.6. The bidder must accept full responsibility for the proper execution & fulfilment of all obligations conditions devolving on under this agreement, as the Principal (s) liable for the due fulfilment of this contract.
- 3.7. This quotation will be evaluated based on the 80/20 points system, specification, correctness of information and/or functionality criteria. All required documentation must be completed in full and submitted.
- 3.8. Offers must comply strictly with the specification.
- 3.9. Only offers that meet or are greater than the specification will be considered.
- 3.10. Late offers will not be considered.
- 3.11. Expired product/s will not be accepted. All products supplied must be valid for a minimum period of six months.
- 3.12. Used/ second-hand products will not be accepted.
- 3.13. A bidder not registered on the Central Suppliers Database or whose verification has failed will not be considered.
- 3.14. All delivery costs must be included in the quoted price for delivery at the prescribed destination.
- 3.15. Only firm prices will be accepted. Such prices must remain firm for the contract period. Non-firm prices (including rates of exchange variations) will not be considered.
- 3.16. In cases where different delivery points influence the pricing, a separate pricing schedule must be submitted for each delivery point.
- 3.17. In the event of a bidder having multiple quotes, only the cheapest according to specification will be considered.
- 3.18. Verification will be conducted to identify if bidders have multiple companies and are cover-quoting for this bid.
- 3.19. In such instances, the Department reserves the right to immediately disqualify such bidders as cover-quoting is an offence that represents both corruption and acquisition fraud.

### 4. SPECIAL INSTRUCTIONS AND NOTICES TO BIDDERS REGARDING THE COMPLETION OF THIS QUOTATION.

- 4.1. Unless inconsistent with or expressly indicated otherwise by the context, the singular shall include the plural and vice versa and with words importing the masculine gender shall include the feminine and the neuter.
- 4.2. Under no circumstances whatsoever may the quotation/bid forms be retyped or redrafted. Photocopies of the original bid documentation may be used, but an original signature must appear on such photocopies.
- 4.3. The bidder is advised to check the number of pages and to satisfy himself that none are missing or duplicated.
- 4.4. Quotations submitted must be complete in all respects. However, where it is identified that information in a bidder's response is incomplete in any respect, the said supplier meets all specification requirements and is lowest to quote, the Department reserves the right to request the bidder to complete/submit such information.
- 4.5. Any alteration made by the bidder must be initialled; failure to do so may render the response invalid.
- 4.6. Use of correcting fluid is prohibited and may render the response invalid.
- 4.7. Quotations will be opened in public as soon as practicable after the closing time of quotation.
- 4.8. Where practical, prices are made public at the time of opening quotations.
- 4.9. If it is desired to make more than one offer against any individual item, such offers should be given on a photocopy of the page in question. Clear indication thereof must be stated on the schedules attached.
- 4.10. The Department is under no obligation to pay suppliers in part for work done if the supplier can no longer for fulfil their obligation.

**5. SPECIAL INSTRUCTIONS REGARDING HAND DELIVERED QUOTATIONS**

- 5.1. Quotation shall be lodged at the address indicated not later than the closing time specified for their receipt, and in accordance with the directives in the quotation documents.
- 5.2. Each quotation shall be addressed in accordance with the directives in the quotation documents and shall be lodged in a separate sealed envelope, with the name and address of the bidder, the quotation number and closing date indicated on the envelope. The envelope shall not contain documents relating to any quotation other than that shown on the envelope. If this provision is not complied with, such quotations/bids may be rejected as being invalid.
- 5.3. All quotations received in sealed envelopes with the relevant quotation numbers on the envelopes are kept unopened in safe custody until the closing time of the quotation/bids. Where, however, a quotation is received open, it shall be sealed. If it is received without a quotation/bid number on the envelope, it shall be opened, the quotation number ascertained, the envelope sealed and the quotation number written on the envelope.
- 5.4. A specific box is provided for the receipt of quotations, and no quotation found in any other box or elsewhere subsequent to the closing date and time of quotation will be considered.
- 5.5. No quotation/bid sent through the post will be considered if it is received after the closing date and time stipulated in the quotation documentation, and proof of posting will not be accepted as proof of delivery.
- 5.6. Quotation documents must not be included in packages containing samples. Such quotations may be rejected as being invalid.

**6. SAMPLES**

- 6.1. In the case of the quote document stipulating that samples are required, the supplier will be informed in due course when samples should be provided to the institution. (This decreases the time of safety and storage risk that may be incurred by the respective institution). The bidders sample will be retained if such bidder wins the contract.
  - (i) If a company/s who has not won the quote requires their samples, they must advise the institution in writing of such.
  - (ii) If samples are not collected within three months of close of quote the institution reserves the right to dispose of them at their discretion.
- 6.2. **Samples must be made available when requested in writing or if stipulated on the document.**
  - (i) If a Bidder fails to provide a sample of their product on offer for scrutiny against the set specification when requested, their offer will be rejected. All testing will be for the account of the bidder.

**7. COMPULSORY SITE INSPECTION / BRIEFING SESSION**

- 7.1. Bidders who fail to attend the compulsory meeting will be disqualified from the evaluation process.
  - (i) The institution has determined that a compulsory site meeting N/A take place
  - (ii) Date        /        /        Time        Place

Institution Stamp:	Institution Site Inspection / briefing session Official  Full Name: .....  Signature: .....  Date: .....
--------------------	--

**8. STATEMENT OF SUPPLIES AND SERVICES**

- 8.1. The contractor shall, when requested to do so, furnish particulars of supplies delivered or services executed. If he/she fails to do so, the Department may, without prejudice to any other rights which it may have, institute inquiries at the expense of the contractor to obtain the required particulars.

**9. SUBMISSION AND COMPLETION OF SBD 6.1**

- 9.1. Should a bidder wish to qualify for preference points they must complete a SBD 6.1 document. Failure by a bidder to provide all relevant information required, will result in such a bidder not being considered for preference point's allocation. The preferences applicable on the closing date will be utilized. Any changes after the closing date will not be considered for that particular quote.

**10. TAX COMPLIANCE REQUIREMENTS**

- 10.1. In the event that the tax compliance status has failed on CSD, *it is the suppliers' responsibility to provide a SARS pin in order for the institution to validate the tax compliance status of the supplier.*
- 10.2. In the event that the institution cannot validate the suppliers' tax clearance on SARS as well as the Central Suppliers Database, *the quote will not be considered and passed over as non-compliant according to National Treasury Instruction Note 4 (a) 2016/17.*

## 11. TAX INVOICE

11.1. A tax invoice shall be in the currency of the Republic of South Africa and shall contain the following particulars:

- |  |  |
|--|--|
| (i) the name, address and registration number of the supplier;                           | (iv) a description and quantity or volume of the goods or services supplied; |
| (ii) the name and address of the recipient;  | (v) the official department order number issued to the supplier;             |
| (iii) an individual serialized number and the date upon which the tax invoice is issued; | (vi) the value of the supply, the amount of tax charged;                     |
|  | (vii) the words tax invoice in a prominent place.                            |

## 12. PATENT RIGHTS

The supplier shall indemnify the **KZN Department of Health** (hereafter known as the purchaser) against all third-party claims of infringement of patent, trademark, or industrial design rights arising from use of the goods or any part thereof by the purchaser.

## 13. PENALTIES

- 13.1. If at any time during the contract period, the service provider is unable to perform in a timely manner, the service provider must notify the institution in writing/email of the cause of and the duration of the delay. Upon receipt of the notification, the institution should evaluate the circumstances and, if deemed necessary, the institution may extend the service provider's time for performance.
- 13.2. In the event of delayed performance that extends beyond the delivery period, the institution is entitled to purchase commodities of a similar quantity and quality as a substitution for the outstanding commodities, without terminating the contract, as well as return commodities delivered at a later stage at the service provider's expense.
- 13.3. Alternatively, the institution may elect to terminate the contract and procure the necessary commodities in order to complete the contract. In the event that the contract is terminated the institution may claim damages from the service provider in the form of a penalty. The service provider's performance should be captured on the service provider database in order to determine whether or not the service provider should be awarded any contracts in the future.
- 13.4. If the supplier fails to deliver any or all of the goods or to perform the services within the period(s) specified in the contract, the purchaser shall, without prejudice to its other remedies under the contract, deduct from the contract price, as a penalty, a sum calculated on the delivered price of the delayed goods or unperformed services using the current prime interest rate calculated for each day of the delay until actual delivery or performance.

## 14. TERMINATION FOR DEFAULT

- 14.1. The purchaser, without prejudice to any other remedy for breach of contract, by written notice of default sent to the supplier, may terminate this contract in whole or in part:
  - (i) if the supplier fails to deliver any or all of the goods within the period(s) specified in the contract,
  - (ii) if the supplier fails to perform any other obligation(s) under the contract; or
  - (iii) if the supplier, in the judgment of the purchaser, has engaged in corrupt or fraudulent practices in competing for or in executing the contract.
- 14.2. In the event the purchaser terminates the contract in whole or in part, the purchaser may procure, upon such terms and in such manner as it deems appropriate, goods, works or services similar to those undelivered, and the supplier shall be liable to the purchaser for any excess costs for such similar goods, works or services.
- 14.3. Where the purchaser terminates the contract in whole or in part, the purchaser may decide to impose a restriction penalty on the supplier by prohibiting such supplier from doing business with the public sector for a period not exceeding 10 years.

## 15. FAILURE TO COMPLY WITH ABOVE WILL RESULT IN YOUR QUOTE BEING PASSED OVER.

**PREFERENCE POINTS CLAIM FORM IN TERMS OF THE PREFERENTIAL PROCUREMENT REGULATIONS 2017**

This preference form must form part of all quotes invited. It contains general information and serves as a claim form for preference points for Broad-Based Black Economic Empowerment (B-BBEE) Status Level of Contribution

**NB: BEFORE COMPLETING THIS FORM, BIDDERS MUST STUDY THE GENERAL CONDITIONS, DEFINITIONS AND DIRECTIVES APPLICABLE IN RESPECT OF B-BBEE, AS PRESCRIBED IN THE PREFERENTIAL PROCUREMENT REGULATIONS, 2017.**

**1. GENERAL CONDITIONS**

1.1 The following preference point systems are applicable to all quotes:

- the 80/20 system for requirements with a Rand value of up to R50 000 000 (all applicable taxes included); and

1.2 The value of this quote is estimated to not exceed R50 000 000 (all applicable taxes included) and therefore the 80/20 preference point system shall be applicable.

1.3 Points for this quote shall be awarded for:

- (a) Price; and
- (b) B-BBEE Status Level of Contributor.

1.4 The maximum points for this quote is allocated as follows:

	<b>POINTS</b>
<b>PRICE</b>	80
<b>B-BBEE STATUS LEVEL OF CONTRIBUTOR</b>	20
<b>Total points for Price and B-BBEE must not exceed</b>	<b>100</b>

1.5 Failure on the part of a bidder to submit proof of B-BBEE Status level of contributor together with the quote, will be interpreted to mean that preference points for B-BBEE status level of contribution are not claimed.

1.6 The purchaser reserves the right to require of a bidder, either before a quote is adjudicated or at any time subsequently, to substantiate any claim in regard to preferences, in any manner required by the purchaser.

**2. DEFINITIONS**

- (a) **"B-BBEE"** means broad-based black economic empowerment as defined in section 1 of the Broad-Based Black Economic Empowerment Act;
- (b) **"B-BBEE status level of contributor"** means the B-BBEE status of an entity in terms of a code of good practice on black economic empowerment, issued in terms of section 9(1) of the Broad-Based Black Economic Empowerment Act;
- (c) **"bid"** means a written offer in a prescribed or stipulated form in response to an invitation by an organ of state for the provision of goods or services, through price quotations, advertised competitive bidding processes or proposals;
- (d) **"Broad-Based Black Economic Empowerment Act"** means the Broad-Based Black Economic Empowerment Act, 2003 (Act No. 53 of 2003);
- (e) **"EME"** means an Exempted Micro Enterprise in terms of a code of good practice on black economic empowerment issued in terms of section 9 (1) of the Broad-Based Black Economic Empowerment Act;
- (f) **"functionality"** means the ability of a tenderer to provide goods or services in accordance with specifications as set out in the tender documents.
- (g) **"prices"** includes all applicable taxes less all unconditional discounts;
- (h) **"proof of B-BBEE status level of contributor"** means:
  - 1) B-BBEE Status level certificate issued by an authorized body or person;
  - 2) A sworn affidavit as prescribed by the B-BBEE Codes of Good Practice;
  - 3) Any other requirement prescribed in terms of the B-BBEE Act;
- (i) **"QSE"** means a qualifying small business enterprise in terms of a code of good practice on black economic empowerment issued in terms of section 9 (1) of the Broad-Based Black Economic Empowerment Act;
- (j) **"rand value"** means the total estimated value of a contract in Rand, calculated at the time of bid invitation, and includes all applicable taxes;



3. POINTS AWARDED FOR PRICE

3.1 THE 80/20 PREFERENCE POINT SYSTEMS

A maximum of 80 points is allocated for price on the following basis:

$$P_s = 80 \left( 1 - \frac{P_t - P_{\min}}{P_{\min}} \right) \text{ Where}$$

- P<sub>s</sub> = Points scored for price of bid under consideration
- P<sub>t</sub> = Price of bid under consideration
- P<sub>min</sub> = price of lowest acceptable bid

4. POINTS AWARDED FOR B-BBEE STATUS LEVEL OF CONTRIBUTOR

4.1 In terms of Regulation 6 (2) and 7 (2) of the Preferential Procurement Regulations, preference points must be awarded to a bidder for attaining the B-BBEE status level of contribution in accordance with the table below:

B-BBEE Status Level of Contributor	Number of points (80/20 system)
1	20
2	18
3	14
4	12
5	8
6	6
7	4
8	2
Non-compliant contributor	0

5. BID DECLARATION

5.1 Bidders who claim points in respect of B-BBEE Status Level of Contribution must complete the following:

6. B-BBEE STATUS LEVEL OF CONTRIBUTOR CLAIMED IN TERMS OF PARAGRAPHS 1.4 AND 4.1

6.1 B-BBEE Status Level of Contributor: = .....(maximum of 20 points)

(Points claimed in respect of paragraph 7.1 must be in accordance with the table reflected in paragraph 4.1 and must be substantiated by relevant proof of B-BBEE status level of contributor.

7. SUB-CONTRACTING  
applicable box

(Tick

YES	<input type="checkbox"/>	NO	<input type="checkbox"/>
-----	--------------------------	----	--------------------------

7.1 Will any portion of the contract be sub-contracted?

7.1.1 If yes, indicate:

- i) What percentage of the contract will be subcontracted.....%
- ii) The name of the sub-contractor.....
- iii) The B-BBEE status level of the sub-contractor.....

8. Whether the sub-contractor is an EME or QSE

(Tick applicable box)

iv) Specify, by ticking the appropriate box, if subcontracting with an enterprise in terms of Preferential Procurement Regulations, 2017:

YES	<input type="checkbox"/>	NO	<input type="checkbox"/>
-----	--------------------------	----	--------------------------

Designated Group: An EME or QSE which is at least 51% owned by:	EME	QSE
Black people	√	√
Black people who are youth		
Black people who are women		
Black people with disabilities		
Black people living in rural or underdeveloped areas or townships		
Cooperative owned by black people		
Black people who are military veterans		
OR		
Any EME		

Any QSE		
---------	--	--

9. DECLARATION WITH REGARD TO COMPANY/FIRM

9.1 Name of company/firm:.....

9.2 VAT registration number:.....

9.3 Company registration number:.....

9.4 TYPE OF COMPANY/ FIRM [TICK APPLICABLE BOX]

- Partnership/Joint Venture / Consortium
- One person business/sole propriety
- Close corporation
- Company
- (Pty) Limited

9.5 DESCRIBE PRINCIPAL BUSINESS ACTIVITIES

.....  
 .....

9.6 COMPANY CLASSIFICATION [TICK APPLICABLE BOX]

- Manufacturer
- Supplier
- Professional service provider
- Other service providers, e.g. transporter, etc.

9.7 Total number of years the company/firm has been in business:.....

9.8 I/we, the undersigned, who is / are duly authorised to do so on behalf of the company/firm, certify that the points claimed, based on the B-BBE status level of contributor indicated in paragraphs 1.4 and 6.1 of the foregoing certificate, qualifies the company/ firm for the preference(s) shown and I / we acknowledge that:

- i) The information furnished is true and correct;
- ii) The preference points claimed are in accordance with the General Conditions as indicated in paragraph 1 of this form;
- iii) In the event of a contract being awarded as a result of points claimed as shown in paragraphs 1.4 and 6.1, the contractor may be required to furnish documentary proof to the satisfaction of the purchaser that the claims are correct;
- iv) If the B-BBEE status level of contributor has been claimed or obtained on a fraudulent basis or any of the conditions of contract have not been fulfilled, the purchaser may, in addition to any other remedy it may have –
  - (a) disqualify the person from the bidding process;
  - (b) recover costs, losses or damages it has incurred or suffered as a result of that person's conduct;
  - (c) cancel the contract and claim any damages which it has suffered as a result of having to make less favourable arrangements due to such cancellation;
  - (d) recommend that the bidder or contractor, its shareholders and directors, or only the shareholders and directors who acted on a fraudulent basis, be restricted by the National Treasury from obtaining business from any organ of state for a period not exceeding 10 years, after the *audi alteram partem* (hear the other side) rule has been applied; and
  - (e) forward the matter for criminal prosecution.

<p>WITNESSES</p> <p>1. ....</p> <p>2. ....</p>
--

<p>.....</p> <p>SIGNATURE(S) OF BIDDERS(S)</p> <p>DATE: .....</p> <p>ADDRESS.....</p> <p>.....</p> <p>.....</p>
---



DD: Specifications  
Enquiries: Miss N.P Zulu  
10 November 2021

**CLAW HAMMER - GEDORE**

FEATURES & SPECIFICATIONS:

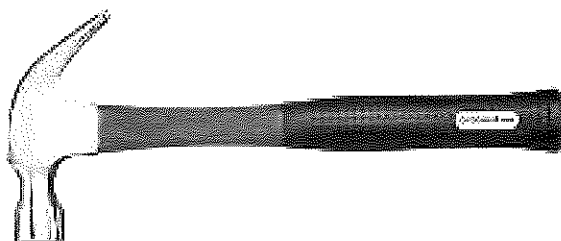

- Steel Claw Hammer – Gedore
- To be made from high carbon steel that is perfectly weighted with improved geometry for balance and control
- Weight : 500g
- Height : 35cm
- Width : 13cm
- Depth : 3cm
- Handle : Rubber

- **Packaging:** Per Each

**General Terms & Conditions:**

- ✓ Please attach a copy of the brochure goods/services which was used quote for the goods/service with your bid/tender document
- ✓ The SABS / SANS Specification Number is to be listed on your bid/tender document
- ✓ If the details of the goods/services bided on differ from above specifications, please attach a complete specification on the goods/service bided on
- ✓ Dundee Hospital reserves the right to request a viewing of the product prior to an order being processed or to get a detailed breakdown of the way the service will be carried out
- ✓ Samples
- Samples will not be accepted with the closing of the bid document.
- A sample meeting will be arranged with selected companies whereby the companies will be invited to forward their samples on a specified date and time.
- Samples must be made available for the sample meeting, Failure to provide a sample upon request will disqualify that particular bided offer
- Samples shall be supplied by the bidder at his/her own cost/risk. Samples must be packaged as per the specification.
- The Dundee Hospital shall not be obliged to pay for such samples.



Dundee Hospital, 121 Mackenzie Street  
Private Bag X2011, Dundee, 3000  
2121111 Fax: 034 2182525 Email: Ntombenhle.Zulu@kznhealth.gov.za

Supply Chain Management

DD: Specifications  
Enquiries: Miss N.P Zulu  
12 November 2021

**GEDORE HOLE SAW KIT**

**Features & Specifications**

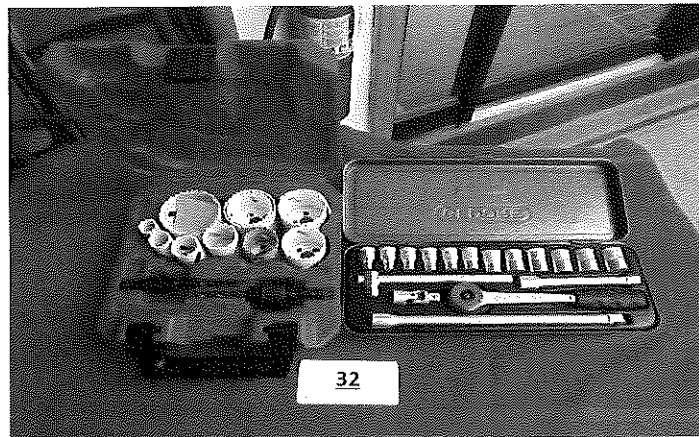

- Product : Carbon Steel Hole saw Set – Tork Craft
- Product Use : Cutting
- Product Material : Carbon Steel
- Feature And Benefits : The Carbon Steel Hole Saw Is Covered With A Black Oxide Finish To Prevent Rust. Holes Can Be Quickly and Efficiently Drilled In Wood, Composite Materials And Plastic.

• **Packaging:** Per Set

• **General Terms & Conditions:**

- ✓ Please attach a copy of the brochure goods/services which was used to quote for the goods/service to your quotation document
- ✓ The **SABS / SANS Specification Number** is to be listed on your quotation document
- ✓ If the details of the goods/services bided on differ from above specifications, please attach a complete specification on the goods/service bided on
- ✓ Dundee Hospital reserves the right to request a viewing of the product prior to an order being processed or to get a detailed breakdown of the way the service will be carried out

✓ **Samples**

- ✓ Samples will be accepted with the closing of the quotation document
- Samples if specifically requested, must be made available with the closing of the quotation document, Failure to provide a sample upon request will disqualify that particular bided offer



DD: Specifications  
Enquiries: Miss N.P Zulu  
10 November 17, 2021

ALLEN KEYS SET - GEDORE

FEATURES & SPECIFICATIONS:



- Allen Keys –Gedore
- Long Ball Point Hex Key Set – Set of 9
- Sizes: (1.5, 2, 2.5, 3, 4, 5, 6, 8, 10mm)
- Ball end for angled or straight driving
- Complete with plastic holder

**Packaging:** Per Set of 9

- General Terms & Conditions:
  - ✓ Please attach a copy of the brochure goods/services which was used to quote for the goods/service to your quotation document
  - ✓ The **SABS / SANS Specification Number** is to be listed on your quotation document
  - ✓ If the details of the goods/services bided on differ from above specifications, please attach a complete specification on the goods/service bided on
  - ✓ Dundee Hospital reserves the right to request a viewing of the product prior to an order being processed or to get a detailed breakdown of the way the service will be carried out



DD: Specifications  
Enquiries: Miss N.P Zulu  
10 November 2021

**MAKITA CORDLESS IMPACT DRILL KIT – BHP454**

FEATURES & SPECIFICATIONS:



NOTICE

- Makita Cordless Impact Drill Kit – BHP454
- Kit to come with:
  - 1 X Makita BHP454 Cordless Impact Drill
  - 2 x BL1815N batteries
  - 1 x DC18RC Charger
  - 1 x Impact Drill Driver Bit Set, Black Oxide 70 Piece Set
  - 1 X Carry Case
- Compact and lightweight design
- All metal gear construction
- Single sleeve keyless chuck
- Ergonomically designed rubberized soft grip
- Variable speed
- Electric brake
- Reversing
- Mechanical 2-Speed
- Carry case included
- Impact Drill Driver Bit Set, Black Oxide 70 Piece Set
  - Professional quality 70-piece bit set
  - Black oxide coating to resist corrosion

- Compatible with all quick-change connector systems, electric or battery-powered drill/drivers, and impact drivers
- Proprietary heat treatment makes for sharper, longer-lasting life
- Manufactured using high-speed steel with precision 135-degree split-point tips

- **Packaging:** Per Kit

**General Terms & Conditions:**

- ✓ Please attach a copy of the brochure goods/services which was used quote for the goods/service with your bid/tender document
- ✓ The SABS / SANS Specification Number is to be listed on your bid/tender document
- ✓ If the details of the goods/services bided on differ from above specifications, please attach a complete specification on the goods/service bided on
- ✓ Dundee Hospital reserves the right to request a viewing of the product prior to an order being processed or to get a detailed breakdown of the way the service will be carried out
- ✓ Samples
  - Samples will not be accepted with the closing of the bid document.
  - A sample meeting will be arranged with selected companies whereby the companies will be invited to forward their samples on a specified date and time.
  - Samples must be made available for the sample meeting, Failure to provide a sample upon request will disqualify that particular bided offer
  - Samples shall be supplied by the bidder at his/her own cost/risk. Samples must be packaged as per the specification.
  - The Dundee Hospital shall not be obliged to pay for such samples.
  - Representative samples will be accepted.
  - The Dundee Hospital reserves the right not to return such samples and to dispose of them at its discretion.
  - Samples must be clearly marked: Item number:
    - Brand Name
    - Name of the Company
    - Bid number
    - Name of the manufacturer/supplier
    - Description of item
    - Date of manufacture
  - The award of this bid will be based on the sample/brand submitted from a manufacturer based on a letter of undertaking, which is compliant to specification. If, during the contract, the awarded supplier wishes to change the item being supplied, the service provider shall apply to Dundee Hospital in writing, giving reasons why they want to change the product being supplied, which Dundee Hospital shall consider. This process will be subject to the sample being submitted to the technical committee for evaluation and if in order, to the adjudication committee for approval. This will be done via the contract management unit of the Dundee Hospital. If there is a change in the product being supplied, and no prior approval has been granted, the Dundee Hospital reserves its right to cancel the contract.
- **N.B Failure to clearly mark the samples submitted shall result in the samples not being evaluated and eliminated from further consideration**
- ✓ There is to be a minimum guarantee period of 12 months for which a certificate is to be submitted together with the goods/services
- ✓ The date of manufacture of goods bided on, is to be not less than 12 months from date of delivery
- ✓ A Material Safety Data Sheet, (If Applicable) is to be submitted with the bid, if applicable
- ✓ Please place your company stamp on this page and return it with your bid/tender. Failure to do so will invalidate your bid/tender
- ✓ Only bidders that fully meet the specifications and all conditions will be considered
- ✓ Offers must comply strictly with the specification
- ✓ Offers exceeding specification requirements will be deemed to comply with the specification
- ✓ The quality of services/ supply must not be less than what is specified
- ✓ Suppliers are not allowed to submit more than one bid/tender document for a specific bid/tender. If it is found on the CENTRAL SUPPLIERS DATABASE that two separate companies are registered to the same person. His or her bid/tenders won't be accepted. And if it is found that two or more bids/tenders with different bid prices have been submitted for the same item/service, by the same bidder/tenderer, than his/her bids/tenders won't be accepted

- 
- KINDLY RETURN ALL DOCUMENTATION WHEN REPLYING



**KWAZULU-NATAL PROVINCE**

**HEALTH**  
REPUBLIC OF SOUTH AFRICA

DIRECTORATE:

Dundee Hospital, 121 Mackenzie Street  
Private Bag X2011, Dundee, 3000  
2121111 Fax: 034 2182525 Email: Ntombenhle.Zulu@kznhealth.gov.za

Supply Chain Management

DD: Specifications  
Enquiries: Miss N.P Zulu  
10 November 2021

### 13MM IMPACT DRILL ELECTRIC – MAKITA HP2050

FEATURES & SPECIFICATIONS:



- 13 mm Impact Drill Electric – Makita
- HP2050 • 13mm Geared chuck
- Slender and compact body with durable metal gear housing
- 720W Powerful 6.0 AMP motor for continuous use
- Powerful 6.0 AMP motor for continuous use
- 2-speed gear change for ideal speed and power
- Forward/Reverse selection
- 2-Speed variable
- 0-1200/2900Rpm

Fighting Disease, Fighting Poverty, Giving Hope



- Max blows per minute 58000  
Variable speed trigger enables user to match the speed to the application for greater versatility
- Depth gauge for "drop-in" type anchors
- All-ball bearing construction for longer tool life
- Adjustable side handle for greater control
- Double insulated
- Extra-low vibration level for reduced operator fatigue
- Dual purpose for "Rotation only" and "Rotation with hammering"
- Built-in torque limiter stops bit rotation when hitting reinforcements
- Industrial strength keyed chuck
- Double Insulation, Variable Speed, Reversing, Mechanical 2-Speed, Torque Limiter
- Handle and depth gauge to be included

Specifications:

➤ Continuous Rating Input	-	720W
	-	Concrete: 230mm
	-	Steel: Hi: 8mm Lo: 13mm
➤ Capacity	-	No Load Speed/Impact per min
	-	Hi: 0-2.900r/min
	-	Lo: 0-1: 1,200r/min
	-	Hi: 0-58,000
	-	Lo: 0-24,000
➤ Overall Length	-	362mm
➤ Net Weight	-	2.5kg
➤ Power Supply Cord	-	2.5m

- **Packaging:** Per Set

**General Terms & Conditions:**

- ✓ Please attach a copy of the brochure goods/services which was used quote for the goods/service with your bid/tender document
- ✓ The SABS / SANS Specification Number is to be listed on your bid/tender document
- ✓ If the details of the goods/services bided on differ from above specifications, please attach a complete specification on the goods/service bided on
- ✓ Dundee Hospital reserves the right to request a viewing of the product prior to an order being processed or to get a detailed breakdown of the way the service will be carried out
- ✓ Samples
  - Samples will not be accepted with the closing of the bid document.
  - A sample meeting will be arranged with selected companies whereby the companies will be invited to forward their samples on a specified date and time.
  - Samples must be made available for the sample meeting, Failure to provide a sample upon request will disqualify that particular bided offer
  - Samples shall be supplied by the bidder at his/her own cost/risk. Samples must be packaged as per the specification.
  - The Dundee Hospital shall not be obliged to pay for such samples.
  - Representative samples will be accepted.
  - The Dundee Hospital reserves the right not to return such samples and to dispose of them at its discretion.
  - Samples must be clearly marked: Item number:
    - Brand Name
    - Name of the Company
    - Bid number
    - Name of the manufacturer/supplier
    - Description of item
    - Date of manufacture

- 
- KINDLY RETURN ALL DOCUMENTATION WHEN REPLYING



DD: Specifications  
Enquiries: Miss N.P Zulu  
12 November 2021

**SPIRIT LEVEL 1.2M - STANLEY**

**FEATURES & SPECIFICATIONS:**

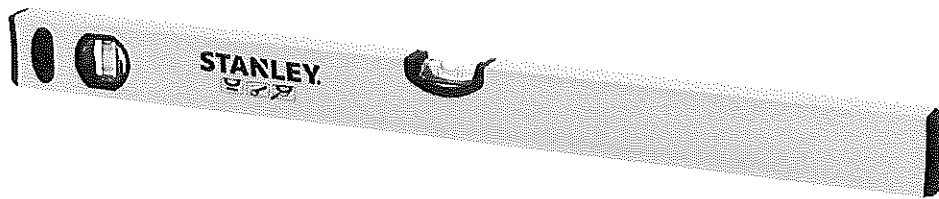

- Spirit Level – 1.2m - Stanley
- Constructed from a reinforced box beam Aluminum body
- Strong yet lightweight aluminium frame suitable for all-purpose durability
- 2 plumb vials for easy readability
- Centre vial with 0.5mm/1m provides excellent accuracy
- Soft material used to make shock absorbing end caps
- Milling surface to provide better accurate measurement
- Casing Material: Powder Coated Aluminium
- Material: Aluminium
- Unit of Measurement: Metric
- Length:1200cm
- Top Read Vial:1
- Plumb Vial:1
- Hang Holes:1
- Weight : 0.8kg
- Length : 1200mm
- Width : 21mm
- Height : 50mm
- **Packaging:** Per Each
- **General Terms & Conditions:**
  - ✓ Please attach a copy of the brochure goods/services which was used to quote for the goods/service to your quotation document
  - ✓ The **SABS / SANS Specification Number** is to be listed on your quotation document
  - ✓ If the details of the goods/services bided on differ from above specifications, please attach a complete specification on the goods/service bided on



## KWAZULU-NATAL PROVINCE

HEALTH  
REPUBLIC OF SOUTH AFRICA

DIRECTORATE:

Dundee Hospital, 121 Mackenzie Street  
Private Bag X2011, Dundee, 3000  
2121111 Fax: 034 2182525 Email: Ntombenhle.Zulu@kznhealth.gov.za

Supply Chain Management

DD: Specifications  
Enquiries: Miss N.P Zulu  
10 November 2021

### STANLEY KNIFE

#### FEATURES & SPECIFICATIONS:

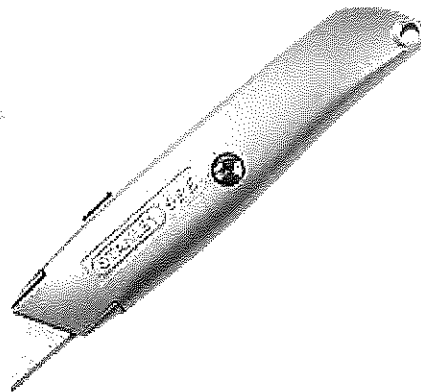

IFICATION

- Stanley Retractable knife
- To have an interlock nose which firmly secures the blade into the knife
- To have a precision die cast zinc body which is strong, durable and lightweight
- To be designed for heavy duty use
- To have a 5 blade position which allows wider usage for a variety of cutting applications
- Blades are to be stored inside the handle
- Handle Length : 5.5" (139.7mm)
- Blade Type : Retractable
- Colour : Grey
- Blade Quantity : 3
- To be supplied with 3 x Replacement Blades
- Packaging: Per Each

#### General Terms & Conditions:

- ✓ Please attach a copy of the brochure goods/services which was used quote for the goods/service with your bid/tender document
- ✓ The SABS / SANS Specification Number is to be listed on your bid/tender document
- ✓ If the details of the goods/services bided on differ from above specifications, please attach a complete specification on the goods/service bided on



DD: Specifications  
Enquiries: Miss N.P Zulu  
12 November 2021

**STANLEY T SQUARE -112cm**

FEATURES & SPECIFICATIONS:

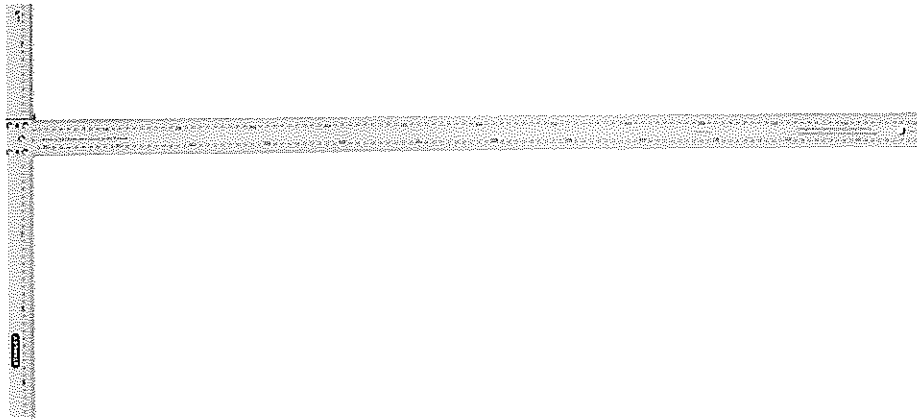

- Stanley T square-112cm
- 2" blade to cut both sides of an outlet box without moving square
- Durable blade springs straight no matter how you flex
- Easy to read black markings
- Markings in inches and eighths
- Notched head for cutting a 4" board in one swoop
- Standard T-square with 1/2" lip
- Material: Metal
- Colour: Yellow
- Dimension: 126(L) x 56 (W) x 1.5 (H) cm
- Packaging: Per Each
- General Terms & Conditions:
  - ✓ Please attach a copy of the brochure goods/services which was used to quote for the goods/service to your quotation document
  - ✓ The **SABS / SANS Specification Number** is to be listed on your quotation document



DD: Specifications  
Enquiries: Miss N.P Zulu  
12 November 2021

**SOLDERING GUN**

FEATURES & SPECIFICATIONS:



- Soldering Gun
- Mains voltage 220-240V~, 50Hz
- Input power 48W
- Temperature 160°C - 480°C
- Adjustable temperature
- Accessory drawer
- Overheat protection
- Mica heating element
- Replaceable tips
- Soft grip on bolt
  
- Packaging: Per Each
  
- General Terms & Conditions:
  - ✓ Please attach a copy of the brochure goods/services which was used to quote for the goods/service to your quotation document
  - ✓ The **SABS / SANS Specification Number** is to be listed on your quotation document
  - ✓ If the details of the goods/services bided on differ from above specifications, please attach a complete specification on the goods/service bided on
  - ✓ Dundee Hospital reserves the right to request a viewing of the product prior to an order being processed or to get a detailed breakdown of the way the service will be carried out
  
  - ✓ **Samples**
  - ✓ Samples will be accepted with the closing of the quotation document



## KWAZULU-NATAL PROVINCE

HEALTH  
REPUBLIC OF SOUTH AFRICA

DIRECTORATE:

Dundee Hospital, 121 Mackenzie Street  
Private Bag X2011, Dundee, 3000  
2121111 Fax: 034 2182525 Email: Ntombenhle.Zulu@kznhealth.gov.za

Supply Chain Management

DD: Specifications  
Enquiries: Miss N.P Zulu  
10 November 2021

### PIPE WRENCH ADJUSTABLE - GEDORE

#### FEATURES & SPECIFICATIONS:

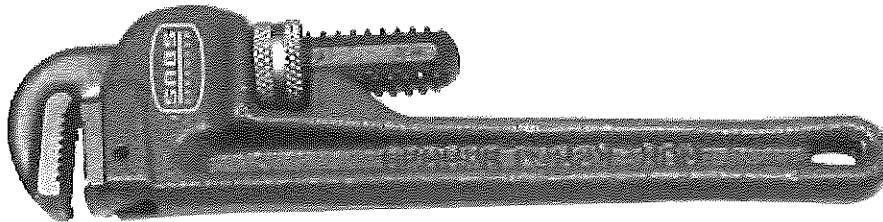

- Pipe Wrench Heavy Duty Adjustable
- Brand : Gedore
- Type : Stillson type
- Material : Drop forged
- Size described is: Maximum opening width x Length
- Size : 18 inch
- Size : 445mm
- 
- **Packaging:** Per Each

#### General Terms & Conditions:

- ✓ Please attach a copy of the brochure goods/services which was used quote for the goods/service with your bid/tender document
- ✓ The SABS / SANS Specification Number is to be listed on your bid/tender document
- ✓ If the details of the goods/services bided on differ from above specifications, please attach a complete specification on the goods/service bided on
- ✓ Dundee Hospital reserves the right to request a viewing of the product prior to an order being processed or to get a detailed breakdown of the way the service will be carried out
- ✓ Samples
- Samples will not be accepted with the closing of the bid document.
- A sample meeting will be arranged with selected companies whereby the companies will be invited to forward their samples on a specified date and time.



## KWAZULU-NATAL PROVINCE

HEALTH  
REPUBLIC OF SOUTH AFRICA

DIRECTORATE:

Dundee Hospital, 121 Mackenzie Street  
Private Bag X2011, Dundee, 3000  
2121111 Fax: 034 2182525 Email: Ntombenhle.Zulu@kznhealth.gov.za

Supply Chain Management

DD: Specifications  
Enquiries: Miss N.P Zulu  
10 November 2021

### PIPE WRENCH ADJUSTABLE - GEDORE

#### FEATURES & SPECIFICATIONS:

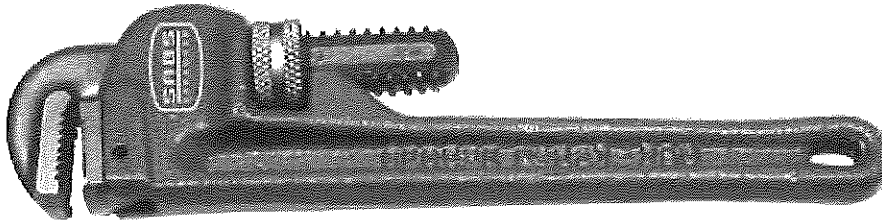

NON

- Pipe Wrench Heavy Duty Adjustable
- Brand : Gedore
- Type : Stillson type
- Material : Drop forged
- Size described is: Maximum opening width x Length
- Size : 10 inch
- Size : 250mm
- 
- **Packaging:** Per Each

#### General Terms & Conditions:

- ✓ Please attach a copy of the brochure goods/services which was used quote for the goods/service with your bid/tender document
- ✓ The SABS / SANS Specification Number is to be listed on your bid/tender document
- ✓ If the details of the goods/services bided on differ from above specifications, please attach a complete specification on the goods/service bided on
- ✓ Dundee Hospital reserves the right to request a viewing of the product prior to an order being processed or to get a detailed breakdown of the way the service will be carried out
- ✓ Samples
- Samples will not be accepted with the closing of the bid document.
- A sample meeting will be arranged with selected companies whereby the companies will be invited to forward their samples on a specified date and time.



## KWAZULU-NATAL PROVINCE

HEALTH  
REPUBLIC OF SOUTH AFRICA

DIRECTORATE:

Dundee Hospital, 121 Mackenzie Street  
Private Bag X2011, Dundee, 3000  
2121111 Fax: 034 2182525 Email: Ntombenhle.Zulu@kznhealth.gov.za

Supply Chain Management

DD: Specifications  
Enquiries: Miss N.P Zulu  
10 November 2021

### PIPE WRENCH ADJUSTABLE - GEDORE

#### FEATURES & SPECIFICATIONS:

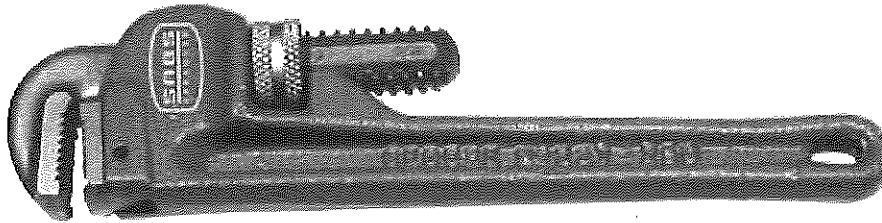

- Pipe Wrench Heavy Duty Adjustable
- Brand : Gedore
- Type : Stillson type
- Material : Drop forged
- Size described is: Maximum opening width x Length
- Size : 24 inch
- Size : 660mm
- 
- **Packaging:** Per Each

#### General Terms & Conditions:

- ✓ Please attach a copy of the brochure goods/services which was used quote for the goods/service with your bid/tender document
- ✓ The SABS / SANS Specification Number is to be listed on your bid/tender document
- ✓ If the details of the goods/services bided on differ from above specifications, please attach a complete specification on the goods/service bided on
- ✓ Dundee Hospital reserves the right to request a viewing of the product prior to an order being processed or to get a detailed breakdown of the way the service will be carried out
- ✓ Samples
- Samples will not be accepted with the closing of the bid document.
- A sample meeting will be arranged with selected companies whereby the companies will be invited to forward their samples on a specified date and time.



- Samples must be made available for the sample meeting, Failure to provide a sample upon request will disqualify that particular bided offer
- Samples shall be supplied by the bidder at his/her own cost/risk. Samples must be packaged as per the specification.
- The Dundee Hospital shall not be obliged to pay for such samples.
- Representative samples will be accepted.
- The Dundee Hospital reserves the right not to return such samples and to dispose of them at its discretion.
- Samples must be clearly marked: Item number:
  - Brand Name
  - Name of the Company
  - Bid number
  - Name of the manufacturer/supplier
  - Description of item
  - Date of manufacture

- The award of this bid will be based on the sample/brand submitted from a manufacturer based on a letter of undertaking, which is compliant to specification. If, during the contract, the awarded supplier wishes to change the item being supplied, the service provider shall apply to Dundee Hospital in writing, giving reasons why they want to change the product being supplied, which Dundee Hospital shall consider. This process will be subject to the sample being submitted to the technical committee for evaluation and if in order, to the adjudication committee for approval. This will be done via the contract management unit of the Dundee Hospital. If there is a change in the product being supplied, and no prior approval has been granted, the Dundee Hospital reserves its right to cancel the contract.

**N.B Failure to clearly mark the samples submitted shall result in the samples not being evaluated and eliminated from further consideration**

- ✓ There is to be a minimum guarantee period of 12 months for which a certificate is to be submitted together with the goods/services
- ✓ The date of manufacture of goods bided on, is to be not less than 12 months from date of delivery
- ✓ A Material Safety Data Sheet, (If Applicable) is to be submitted with the bid, If applicable
- ✓ Please place your company stamp on this page and return it with your bid/tender. Failure to do so will invalidate your bid/tender
- ✓ Only bidders that fully meet the specifications and all conditions will be considered
- ✓ Offers must comply strictly with the specification
- ✓ Offers exceeding specification requirements will be deemed to comply with the specification
- ✓ The quality of services/ supply must not be less than what is specified
- ✓ Suppliers are not allowed to submit more than one bid/tender document for a specific bid/tender. If it is found on the CENTRAL SUPPLIERS DATABASE that two separate companies are registered to the same person. His or her bid/tenders won't be accepted. And if it is found that two or more bids/tenders with different bid prices have been submitted for the same item/service, by the same bidder/tenderer, than his/her bids/tenders won't be accepted
- ✓ The successful bidder is to provide in-house training on the use and maintenance of the goods/services as requested. In the case of equipment, training is to be provided once the unit once the unit is installed - (Within 30 days of installation)

• General Terms & Conditions :

- ✓ Please attach a copy of the brochure goods/services which was used to quote for the goods/service to your quotation document
- ✓ The **SABS / SANS Specification Number** is to be listed on your quotation document
- ✓ If the details of the goods/services bided on differ from above specifications, please attach a complete specification on the goods/service bided on
- ✓ Dundee Hospital reserves the right to request a viewing of the product prior to an order being processed or to get a detailed breakdown of the way the service will be carried out
- ✓ **Samples**
- ✓ Samples will be accepted with the closing of the quotation document
- Samples if specifically requested, must be made available with the closing of the quotation document, Failure to provide a sample upon request will disqualify that particular bided offer

---

• KINDLY RETURN ALL DOCUMENTATION WHEN REPLYING

- Samples shall be supplied by the bidder at his/her own cost/risk. Samples must be packaged as per the specification.
- The Dundee Hospital shall not be obliged to pay for such samples.
- Representative samples will be accepted.
- The Dundee Hospital reserves the right not to return such samples and to dispose of them at its discretion.
- Samples must be clearly marked: Item number:
  - Brand Name
  - Name of the Company
  - Quote number
  - Name of the manufacturer/supplier
  - Description of item
  - Date of manufacture
- The award of this quotation will be based on the sample/brand submitted from a manufacturer based on a letter of undertaking, which is compliant to specification. If, during the contract, the awarded supplier wishes to change the item being supplied, the service provider shall apply to Dundee Hospital in writing, giving reasons why they want to change the product being supplied, which Dundee Hospital shall consider. This process will be subject to the sample being submitted to the technical committee for evaluation and if in order, to the adjudication committee for approval. This will be done via the contract management unit of the Dundee Hospital. If there is a change in the product being supplied, and no prior approval has been granted, the Dundee Hospital reserves its right to cancel the contract.  
N.B Failure to clearly mark the samples submitted shall result in the samples not being evaluated and eliminated from further consideration
- ✓ There is to be a minimum guarantee period of 12 months for which a certificate is to be submitted together with the goods/services
- ✓ The date of manufacture of goods bided on, is to be not less than 12 months from date of delivery
- ✓ A Material Safety Data Sheet, (If Applicable) is to be submitted with the bid, if applicable
- ✓ Please place your company stamp on this the bid document price page and on the specification page and return it with your bid/tender. Failure to do so will invalidate your quotation
- ✓ Only bidders that fully meet the specifications and all conditions will be considered
- ✓ Offers must comply strictly with the specification
- ✓ Offers exceeding specification requirements will be deemed to comply with the specification
- ✓ The quality of services/ supply must not be less than what is specified
- ✓ Suppliers are not allowed to submit more than one quotation document for a specific bid/tender. If it is found on the CENTRAL SUPPLIERS DATABASE that two separate companies are registered to the same person. His or her quotation won't be accepted. And if it is found that two or more bids/tenders with different bid prices have been submitted for the same item/service, by the same tenderer, than his/her quotation won't be accepted
- ✓ The successful tenderer is to provide in-house training on the use and maintenance of the goods/services as requested. In the case of equipment, training is to be provided once the unit once the unit is installed - (Within 30 days of installation)
- ✓ Guarantee Period
  - The Service Provider shall unconditionally guarantee all servicing and repair work performed together with all materials and spare parts (inclusive of electrical components) supplied by him/her for a minimum period of six (6) months from the date of acceptance of the Works.
  - The Service Provider shall unconditionally guarantee all new, replacement or additional equipment, and installations (inclusive of all electrical components) for a minimum period of twelve (12) months from the date of the First Delivery Certificate.
  - The guarantee shall cover the performance of the Works and any defects due to inferior materials and/or workmanship of the Service Provider, or any of his/her Sub-Contractors, fair wear and tear excepted, and the Service Provider shall repair any such defects without delay and at his/her own cost. This guarantee shall include malfunction, and water exhaust, oil, or air leaks etc. and adjustments.
  - Should any part of the complete Works perform unsatisfactorily so as to become detrimental to its functional use the service provider shall replace any such part of the complete Works with equipment as prescribed by the Employer without delay and at his/her own cost.
  - If any defects are not remedied within the period specified by the Employer, the Employer shall have such defect repaired at the risk and cost of the Service Provider, by another service provider whom the employer deems to be proficient in the work, without prejudice to any rights the employer has against the defaulting service provider. The Employer will give written notice to the service provider of such instances where he/she appoints another Service Provider to remedy defects in the Works.

---

• KINDLY RETURN ALL DOCUMENTATION WHEN REPLYING



N Dlomo  
SCM Demand Management



L.C Moodley  
Maintenance

DUNDEE HOSPITAL SPECIFICATION

- 
- KINDLY RETURN ALL DOCUMENTATION WHEN REPLYING



DD: Specifications  
Enquiries: Miss N.P Zulu  
27 October 2021

**POLYCOP PIPE**

**FEATURES & SPECIFICATIONS:**

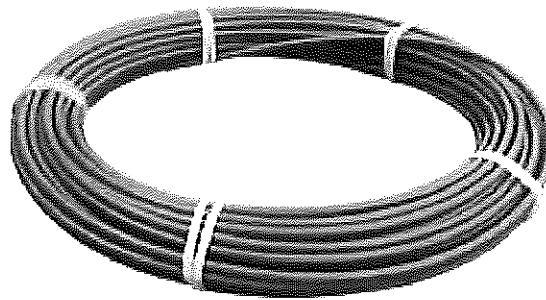

- Product : Polycop Pipe
- Product use : Water Supply
- Colour : Red
- SABS Approved : Yes
- Wall Thickness : 2mm
- Duty Rating : Heavy-duty
- Material : Polypropylene
- Class : Class 2
- Pipe Stiffness : 600kpa
- Pipe End : Plain
- Application : Commercial/Residential

- Size: Diameter : 15mm

- Packaging: Per 100m Roll

**General Terms & Conditions:**

- ✓ Please attach a copy of the brochure goods/services which was used quote for the goods/service with your bid/tender document
- ✓ The SABS / SANS Specification Number is to be listed on your bid/tender document
- ✓ If the details of the goods/services bided on differ from above specifications, please attach a complete specification on the goods/service bided on
- ✓ Dundee Hospital reserves the right to request a viewing of the product prior to an order being processed or to get a detailed breakdown of the way the service will be carried out
- ✓ Samples
- Samples will not be accepted with the closing of the bid document.



DD: Specifications  
Enquiries: Miss N.P Zulu  
27 October 2021

CONEX ELBOW C-C

FEATURES & SPECIFICATIONS:



- Compression Copper Fitting
  - Cobra - Elbow 90D: D-4XS
  - To be made from DZR Brass: Dezincification Resistant Brass
  - As per SANS 1067 Part 1 and Part 2
  - Sizes : 15mm
- 
- Packaging: Per Each

**General Terms & Conditions:**

- ✓ Please attach a copy of the brochure goods/services which was used quote for the goods/service with your bid/tender document
- ✓ The SABS / SANS Specification Number is to be listed on your bid/tender document
- ✓ If the details of the goods/services bided on differ from above specifications, please attach a complete specification on the goods/service bided on
- ✓ Dundee Hospital reserves the right to request a viewing of the product prior to an order being processed or to get a detailed breakdown of the way the service will be carried out
- ✓ Samples
  - Samples will not be accepted with the closing of the bid document.
  - A sample meeting will be arranged with selected companies whereby the companies will be invited to forward their samples on a specified date and time.
  - Samples must be made available for the sample meeting, Failure to provide a sample upon request will disqualify that particular bided offer
  - Samples shall be supplied by the bidder at his/her own cost/risk. Samples must be packaged as per the specification.
  - The Dundee Hospital shall not be obliged to pay for such samples.
  - Representative samples will be accepted.



**COPPER TUBE CLASS 2**

FEATURES & SPECIFICATIONS:

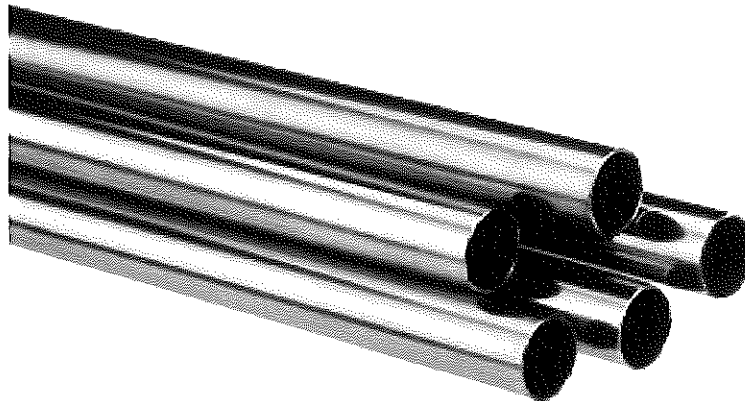

- Copper Tube
- Class 2
- SABS Certified – SANS 460
- TA 460/0 EXTRA LIGHT - HARD DRAWN
- 5,5m straight lengths
- Identification: Yellow or clear end-caps on bundle
- Pressure tested
- HD
- Maximum Working Pressure: 88.0 Bars
- Size: 15mm x 5.5m
  
- **Packaging: Per Each Length**

**General Terms & Conditions:**

- ✓ Please attach a copy of the brochure goods/services which was used quote for the goods/service with your bid/tender document
- ✓ The SABS / SANS Specification Number is to be listed on your bid/tender document
- ✓ If the details of the goods/services bided on differ from above specifications, please attach a complete specification on the goods/service bided on
- ✓ Dundee Hospital reserves the right to request a viewing of the product prior to an order being processed or to get a detailed breakdown of the way the service will be carried out
- ✓ Samples
- Samples will not be accepted with the closing of the bid document.
- A sample meeting will be arranged with selected companies whereby the companies will be invited to forward their samples on a specified date and time.



**COPPER TUBE CLASS 2**

FEATURES & SPECIFICATIONS:

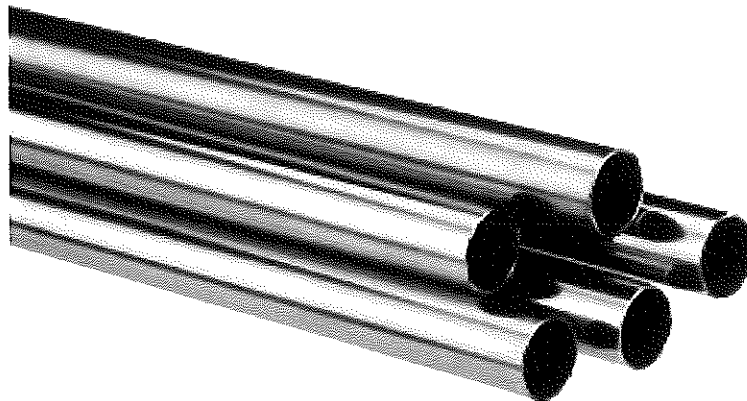

- Copper Tube
- Class 2
- SABS Certified – SANS 460
- TA 460/0 EXTRA LIGHT - HARD DRAWN
- 5,5m straight lengths
- Identification: Yellow or clear end-caps on bundle
- Pressure tested
- HD
- Maximum Working Pressure: 88.0 Bars
- Size: 28mm
  
- **Packaging: Per Each Length**

**General Terms & Conditions:**

- ✓ Please attach a copy of the brochure goods/services which was used quote for the goods/service with your bid/tender document
- ✓ The SABS / SANS Specification Number is to be listed on your bid/tender document
- ✓ If the details of the goods/services bided on differ from above specifications, please attach a complete specification on the goods/service bided on
- ✓ Dundee Hospital reserves the right to request a viewing of the product prior to an order being processed or to get a detailed breakdown of the way the service will be carried out
- ✓ Samples
- Samples will not be accepted with the closing of the bid document.
- A sample meeting will be arranged with selected companies whereby the companies will be invited to forward their samples on a specified date and time.



DD: Specifications  
Enquiries: Miss N.P Zulu  
27 October 2021

COPPER TUBE CLASS 2

FEATURES & SPECIFICATIONS:

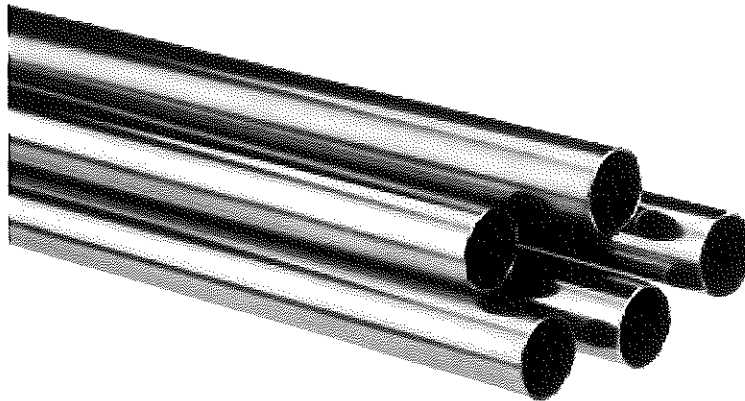

- Copper Tube
- Class 2
- SABS Certified – SANS 460
- TA 460/0 EXTRA LIGHT - HARD DRAWN
- 5,5m straight lengths
- Identification: Yellow or clear end-caps on bundle
- Pressure tested
- HD
- Maximum Working Pressure: 88.0 Bars
- Size: 22mm
  
- **Packaging: Per Each Length**

**General Terms & Conditions:**

- ✓ Please attach a copy of the brochure goods/services which was used quote for the goods/service with your bid/tender document
- ✓ The SABS/SANS Specification Number is to be listed on your bid/tender document
- ✓ If the details of the goods/services bided on differ from above specifications, please attach a complete specification on the goods/service bided on
- ✓ Dundee Hospital reserves the right to request a viewing of the product prior to an order being processed or to get a detailed breakdown of the way the service will be carried out
- ✓ Samples
- Samples will not be accepted with the closing of the bid document.
- A sample meeting will be arranged with selected companies whereby the companies will be invited to forward their samples on a specified date and time.





DD: Specifications  
Enquiries: Miss N.P Zulu  
27 October 2021

CONEX ELBOW C-C

FEATURES & SPECIFICATIONS:



- Compression Copper Fitting
- Cobra - Elbow 90D: D-4XS
- To be made from DZR Brass: Dezincification Resistant Brass
- As per SANS 1067 Part 1 and Part 2
- Sizes : 22mm

- **Packaging: Per Each**

**General Terms & Conditions:**

- ✓ Please attach a copy of the brochure goods/services which was used quote for the goods/service with your bid/tender document
- ✓ The SABS / SANS Specification Number is to be listed on your bid/tender document
- ✓ If the details of the goods/services bided on differ from above specifications, please attach a complete specification on the goods/service bided on
- ✓ Dundee Hospital reserves the right to request a viewing of the product prior to an order being processed or to get a detailed breakdown of the way the service will be carried out
- ✓ Samples
- Samples will not be accepted with the closing of the bid document.
- A sample meeting will be arranged with selected companies whereby the companies will be invited to forward their samples on a specified date and time.
- Samples must be made available for the sample meeting, Failure to provide a sample upon request will disqualify that particular bided offer
- Samples shall be supplied by the bidder at his/her own cost/risk. Samples must be packaged as per the specification.
- The Dundee Hospital shall not be obliged to pay for such samples.
- Representative samples will be accepted.



DD: Specifications  
Enquiries: Miss N.P Zulu  
27 October 2021

**CONEX COPPER TO MALE IRON STRAIGHT COUPLER**

**Features & Specifications:**

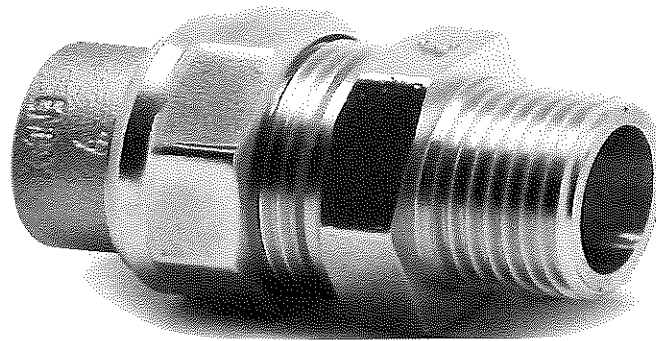

- Compression Copper Fitting
- Straight Coupler Conex
- Copper to Male Iron Connection
- Cobra
- SABS/SANS 1067 Part 1 and Part 2
- Sizes :  
22mm x 3/4"
  
- Packaging: Per Each

**General Terms & Conditions.**

- ✓ Please attach a copy of the brochure goods/services which was used quote for the goods/service with your bid/tender document
- ✓ The SABS / SANS Specification Number is to be listed on your bid/tender document
- ✓ If the details of the goods/services bided on differ from above specifications, please attach a complete specification on the goods/service bided on
- ✓ Dundee Hospital reserves the right to request a viewing of the product prior to an order being processed or to get a detailed breakdown of the way the service will be carried out
- ✓ Samples
- Samples will not be accepted with the closing of the bid document.
- A sample meeting will be arranged with selected companies whereby the companies will be invited to forward their samples on a specified date and time.
- Samples must be made available for the sample meeting, Failure to provide a sample upon request will disqualify that particular bided offer
- Samples shall be supplied by the bidder at his/her own cost/risk. Samples must be packaged as per the specification.