



KWAZULU-NATAL PROVINCE  
HEALTH  
REPUBLIC OF SOUTH AFRICA

# KZN Health Intranet

KZN HEALTH

- HOME
- CORPORATE INFORMATION
- COMPONENTS
- DIRECTORY
- DISTRICT OFFICES
- HEALTH FACILITIES

KZN Health > Components > Supply Chain Management

## AdvertQuote



KWAZULU-NATAL PROVINCE  
HEALTH  
REPUBLIC OF SOUTH AFRICA

## Quotation Advert

Opening Date: 2021-12-14

Closing Date: 2021-12-22

Closing Time: 11:00

### INSTITUTION DETAILS

Institution Name: Regional Landry Cato Manor

Province: KwaZulu-Natal

Department or Entity: Department of Health

Division or section: Central Supply Chain Management

Place where goods / services is required: 800 BELLAIR ROAD DURBAN

Date Submitted: 2021-12-13

### ITEM CATEGORY AND DETAILS

Quotation Number: ZNQ: ZNQ72/2122-LCM

Item Category: Goods

Item Description: SUPPLY AND DELIVER TOOLS

Quantity (if supplies): VARIOUS

### COMPULSORY BRIEFING SESSION / SITE VISIT

Select Type: Not Applicable

Date:

Time:

Venue:

QUOTES CAN BE COLLECTED FROM: 800 BELLAIR ROAD DURBAN

QUOTES SHOULD BE DELIVERED TO: 310 JABU NDLOVU STREET PIETERMARITZBURG

### ENQUIRIES REGARDING THE ADVERT MAY BE DIRECTED TO:

Name: A.N MOODLEY

Email:

Contact Number: 031 2402878

Finance Manager Name: P.L MAKHOBHA

Finance Manager Signature:

No late quotes will be considered

STANDARD QUOTE DOCUMENTATION OVER R30 000.00

YOU ARE HEREBY INVITED TO QUOTE FOR REQUIREMENTS AT: REGIONAL LAUNDRY CATO MANOR
DATE ADVERTISED: 14/12/2021 ..... CLOSING DATE: 22/12/2021 ..... CLOSING TIME: 11:00
FACSIMILE NUMBER: ..... E-MAIL ADDRESS: alvin.moodley@kznhealth.gov.za
PHYSICAL ADDRESS: 800 BELLAIR ROAD MAYVILLE , DURBAN

QUOTE NUMBER: ZNQ72/2122-LCM  
 DESCRIPTION: SUPPLY AND DELIVER OF TOOLS AS PER SPECIFICATION  
 CONTRACT PERIOD: ONCE OFF ..... VALIDITY PERIOD 60 Days ..... SARS PIN:.....  
 (if applicable)

CENTRAL SUPPLIER DATABASE REGISTRATION (CSD) NO. 

--	--	--	--	--	--	--	--	--	--	--	--	--	--	--	--	--	--

UNIQUE REGISTRATION REFERENCE  

--	--	--	--	--	--	--	--	--	--	--	--	--	--	--	--	--	--	--	--	--	--	--	--	--	--	--	--	--	--	--	--	--	--	--	--	--	--

DEPOSITED IN THE QUOTE BOX SITUATED AT (STREET ADDRESS)  
 310 JABU INDLOVU STREET ,SCM BUILDING ,PMB  
 .....

Bidders should ensure that quotes are delivered timeously to the correct address. If the quote is late, it will not be accepted for consideration.  
 The quote box is open from 08:00 to 15:30.

QUOTATIONS MUST BE SUBMITTED ON THE OFFICIAL FORMS – (NOT TO BE RETYPED)

THIS QUOTE IS SUBJECT TO THE PREFERENTIAL PROCUREMENT POLICY FRAMEWORK ACT AND THE PREFERENTIAL PROCUREMENT REGULATIONS, 2011, THE GENERAL CONDITIONS OF CONTRACT (GCC) AND, IF APPLICABLE, ANY OTHER SPECIAL CONDITIONS OF CONTRACT.

THE FOLLOWING PARTICULARS MUST BE FURNISHED (FAILURE TO DO SO MAY RESULT IN YOUR QUOTE BEING DISQUALIFIED)
---

NAME OF BIDDER .....

POSTAL ADDRESS .....

STREET ADDRESS .....

TELEPHONE NUMBER CODE ..... NUMBER ..... FACSIMILE NUMBER CODE ..... NUMBER .....

CELLPHONE NUMBER .....

E-MAIL ADDRESS .....

VAT REGISTRATION NUMBER (If VAT vendor) .....

HAS A B-BBEE STATUS LEVEL VERIFICATION CERTIFICATE BEEN SUBMITTED? (SBD 6.1) YES  NO   
 [A B-BBEE STATUS LEVEL VERIFICATION CERTIFICATE/SWORN AFFIDAVIT (FOR EMEs & QSEs) MUST BE SUBMITTED TO QUALIFY FOR PREFERENCE POINTS FOR B-BBEE]



DECLARATION OF INTEREST

1. Any legal person, including persons employed by the state<sup>1</sup>, or persons having a kinship with persons employed by the state, including a blood relationship, may make an offer or offers in terms of this invitation to quote (includes a price quotation, advertised competitive quote, limited quote or proposal). In view of possible allegations of favouritism, should the resulting quote, or part thereof, be awarded to persons employed by the state or to persons connected with or related to them, it is required that the bidder or his/her authorised representative declare his/her position in relation to the evaluating/adjudicating authority where-
  - the bidder is employed by the state; and/or
  - the legal person on whose behalf the bidding document is signed, has a relationship with persons/a person who are/is involved in the evaluation and or adjudication of the quote(s), or where it is known that such a relationship exists between the person or persons for or on whose behalf the declarant acts and persons who are involved with the evaluation and or adjudication of the quote.
2. In order to give effect to the above, the following questionnaire must be completed and submitted with the quote.

- 2.1. Full Name of bidder/representative.....
- 2.2. Identity Number: .....
- 2.3. Position occupied in the Company (director, trustee, shareholder?): .....
- 2.4. Company Registration Number: .....
- 2.5. Tax Reference Number: .....
- 2.6. VAT Registration Number: .....
- 2.7. The names of all directors / trustees / shareholders / members, their individual identity numbers, tax reference numbers and, if applicable, employee / persal numbers must be indicated in paragraph 3 below. [TICK APPLICABLE]
- 2.8. Are you or any person connected with the bidder presently employed by the state? YES  NO
- 2.8.1. If so, furnish the following particulars:
 

Name of person / director / trustee / shareholder/ member: .....

Name of state institution at which you or the person connected to the bidder is employed:.....

Position occupied in the state institution: .....Any other particulars:.....
- 2.8.2. If you are presently employed by the state, did you obtain the appropriate authority to undertake remunerative work outside employment in the public sector? YES  NO
- 2.8.2.1. If yes, did you attach proof of such authority to the quote document?  
 (Note: Failure to submit proof of such authority, where applicable, may result in the disqualification of the quote.)
- 2.8.2.2. If no, furnish reasons for non-submission of such proof: .....
- 2.9. Did you or your spouse, or any of the company's directors / trustees / shareholders / members or their spouses conduct business with the state in the previous twelve months? YES  NO
- 2.9.1. If so, furnish particulars:.....
- 2.10. Do you, or any person connected with the bidder, have any relationship (family, friend, other) with a person employed by the state and who may be involved with the evaluation and or adjudication of this quote? YES  NO
- 2.10.1. If so, furnish particulars:.....
- 2.11. Are you, or any person connected with the bidder, aware of any relationship (family, friend, other) between any other bidder and any person employed by the state who may be involved with the evaluation and or adjudication of this quote? YES  NO
- 2.11.1. If so, furnish particulars:.....
- 2.12. Do you or any of the directors / trustees / shareholders / members of the company have any interest in any other related companies whether or not they are bidding for this contract? YES  NO
- 2.12.1. If so, furnish particulars:.....

3. Full details of directors / trustees / members / shareholders.

NB: The Department Of Health will validate details of directors / trustees / members / shareholders on CSD. It is the suppliers' responsibility to ensure that their details are up-to-date and verified on CSD. If the Department cannot validate the information on CSD, the quote will not be considered and passed over as non-compliant according to National Treasury Instruction Note 4 (a) 2016/17.

4. DECLARATION

I, THE UNDERSIGNED (NAME).....CERTIFY THAT THE INFORMATION FURNISHED IN PARAGRAPHS 2.

I ACCEPT THAT THE STATE MAY REJECT THE QUOTE OR ACT AGAINST ME SHOULD THIS DECLARATION PROVE TO BE FALSE.

..... Name of bidder	..... Signature	..... Position	..... Date
-------------------------	--------------------	-------------------	---------------

"State" means -

- |   |   |
|---|---|
| a) any national or provincial department, national or provincial public entity or constitutional institution within the meaning of the Public Finance Management Act, 1999 (Act No. 1 of 1999);<br>b) any municipality or municipal entity; | c) provincial legislature;<br>d) national Assembly or the national Council of provinces; or<br>e) Parliament. |
|---|---|
- "Shareholder" means a person who owns shares in the company and is actively involved in the management of the enterprise or business and exercises control over the enterprise.

## SPECIAL CONTRACT CONDITIONS OF QUOTATIONS

### 1. AMENDMENT OF CONTRACT

- 1.1. Any amendment to or renunciation of the provisions of the contract shall at all times be done in writing and shall be signed by both parties.

### 2. CHANGE OF ADDRESS

- 2.1. Bidders must advise the Department of Health (institution where the offer was submitted) should their address (*domicilium citandi et executandi*) details change from the time of bidding to the expiry of the contract.

### 3. GENERAL CONDITIONS ATTACHED TO THIS QUOTATION

- 3.1. The Department is under no obligation to accept the lowest or any quote.
- 3.2. The Department reserves the right to communicate in writing with vendors in cases where information is incomplete or where there are obscurities regarding technical aspects of the offer, to obtain confirmation of prices or preference claims in cases where it is evident that a typing, written, transfer or unit error has been made, to investigate the vendor's standing and ability to complete the supply/service satisfactorily.
- 3.3. **ALL DECISIONS TAKEN BY THE DEPARTMENT ARE FINAL, INCLUDING THE AWARD OF THIS QUOTATION.**
- 3.4. The price quoted must include VAT (if VAT vendor). However, it must be noted that the Department reserves the right to evaluate all quotations excluding VAT as some bidders may not be VAT vendors.
- 3.5. The bidder must ensure the correctness & validity of the quotation:
- (i) *that the price(s), rate(s) & preference quoted cover all for the work/item (s) & accept that any mistakes regarding the price (s) & calculations will be at the bidder's risk*
  - (ii) *it is the responsibility of the bidder to confirm receipt of their quotation and to keep proof thereof.*
- 3.6. The bidder must accept full responsibility for the proper execution & fulfilment of all obligations conditions devolving on under this agreement, as the Principal (s) liable for the due fulfilment of this contract.
- 3.7. This quotation will be evaluated based on the 80/20 points system, specification, correctness of information and/or functionality criteria. All required documentation must be completed in full and submitted.
- 3.8. Offers must comply strictly with the specification.
- 3.9. Only offers that meet or are greater than the specification will be considered.
- 3.10. Late offers will not be considered.
- 3.11. Expired product/s will not be accepted. All products supplied must be valid for a minimum period of six months.
- 3.12. Used/ second-hand products will not be accepted.
- 3.13. A bidder not registered on the Central Suppliers Database or whose verification has failed will not be considered.
- 3.14. All delivery costs must be included in the quoted price for delivery at the prescribed destination.
- 3.15. Only firm prices will be accepted. Such prices must remain firm for the contract period. Non-firm prices (including rates of exchange variations) will not be considered.
- 3.16. In cases where different delivery points influence the pricing, a separate pricing schedule must be submitted for each delivery point.
- 3.17. In the event of a bidder having multiple quotes, only the cheapest according to specification will be considered.
- 3.18. Verification will be conducted to identify if bidders have multiple companies and are cover-quoting for this bid.
- 3.19. In such instances, the Department reserves the right to immediately disqualify such bidders as cover-quoting is an offence that represents both corruption and acquisition fraud.

### 4. SPECIAL INSTRUCTIONS AND NOTICES TO BIDDERS REGARDING THE COMPLETION OF THIS QUOTATION.

- 4.1. Unless inconsistent with or expressly indicated otherwise by the context, the singular shall include the plural and vice versa and with words importing the masculine gender shall include the feminine and the neuter.
- 4.2. Under no circumstances whatsoever may the quotation/bid forms be retyped or redrafted. Photocopies of the original bid documentation may be used, but an original signature must appear on such photocopies.
- 4.3. The bidder is advised to check the number of pages and to satisfy himself that none are missing or duplicated.
- 4.4. Quotations submitted must be complete in all respects. However, where it is identified that information in a bidder's response is incomplete in any respect, the said supplier meets all specification requirements and is lowest to quote, the Department reserves the right to request the bidder to complete/submit such information.
- 4.5. Any alteration made by the bidder must be initialled; failure to do so may render the response invalid.
- 4.6. Use of correcting fluid is prohibited and may render the response invalid.
- 4.7. Quotations will be opened in public as soon as practicable after the closing time of quotation.
- 4.8. Where practical, prices are made public at the time of opening quotations.
- 4.9. If it is desired to make more than one offer against any individual item, such offers should be given on a photocopy of the page in question. Clear indication thereof must be stated on the schedules attached.
- 4.10. The Department is under no obligation to pay suppliers in part for work done if the supplier can no longer for fulfil their obligation.

**5. SPECIAL INSTRUCTIONS REGARDING HAND DELIVERED QUOTATIONS**

- 5.1. Quotation shall be lodged at the address indicated not later than the closing time specified for their receipt, and in accordance with the directives in the quotation documents.
- 5.2. Each quotation shall be addressed in accordance with the directives in the quotation documents and shall be lodged in a separate sealed envelope, with the name and address of the bidder, the quotation number and closing date indicated on the envelope. The envelope shall not contain documents relating to any quotation other than that shown on the envelope. If this provision is not complied with, such quotations/bids may be rejected as being invalid.
- 5.3. All quotations received in sealed envelopes with the relevant quotation numbers on the envelopes are kept unopened in safe custody until the closing time of the quotation/bids. Where, however, a quotation is received open, it shall be sealed. If it is received without a quotation/bid number on the envelope, it shall be opened, the quotation number ascertained, the envelope sealed and the quotation number written on the envelope.
- 5.4. A specific box is provided for the receipt of quotations, and no quotation found in any other box or elsewhere subsequent to the closing date and time of quotation will be considered.
- 5.5. No quotation/bid sent through the post will be considered if it is received after the closing date and time stipulated in the quotation documentation, and proof of posting will not be accepted as proof of delivery.
- 5.6. Quotation documents must not be included in packages containing samples. Such quotations may be rejected as being invalid.

**6. SAMPLES**

- 6.1. In the case of the quote document stipulating that samples are required, the supplier will be informed in due course when samples should be provided to the institution. (This decreases the time of safety and storage risk that may be incurred by the respective institution). The bidders sample will be retained if such bidder wins the contract.
  - (i) If a company/s who has not won the quote requires their samples, they must advise the institution in writing of such.
  - (ii) If samples are not collected within three months of close of quote the institution reserves the right to dispose of them at their discretion.
- 6.2. **Samples must be made available when requested in writing or if stipulated on the document.**
  - (i) If a Bidder fails to provide a sample of their product on offer for scrutiny against the set specification when requested, their offer will be rejected. All testing will be for the account of the bidder.

**7. COMPULSORY SITE INSPECTION / BRIEFING SESSION**

- 7.1. Bidders who fail to attend the compulsory meeting will be disqualified from the evaluation process.
  - (i) The institution has determined that a compulsory site meeting  take place
  - (ii) Date \_\_\_\_/\_\_\_\_/\_\_\_\_ Time \_\_\_\_:\_\_\_\_ Place \_\_\_\_\_

Institution Stamp:	Institution Site inspection / briefing session Official  Full Name: .....  Signature: .....  Date: .....
--------------------	--

**8. STATEMENT OF SUPPLIES AND SERVICES**

- 8.1. The contractor shall, when requested to do so, furnish particulars of supplies delivered or services executed. If he/she fails to do so, the Department may, without prejudice to any other rights which it may have, institute inquiries at the expense of the contractor to obtain the required particulars.

**9. SUBMISSION AND COMPLETION OF SBD 6.1**

- 9.1. Should a bidder wish to qualify for preference points they must complete a SBD 6.1 document. Failure by a bidder to provide all relevant information required, will result in such a bidder not being considered for preference point's allocation. The preferences applicable on the closing date will be utilized. Any changes after the closing date will not be considered for that particular quote.

**10. TAX COMPLIANCE REQUIREMENTS**

- 10.1. In the event that the tax compliance status has failed on CSD, **it is the suppliers' responsibility to provide a SARS pin in order for the institution to validate the tax compliance status of the supplier.**
- 10.2. In the event that the institution cannot validate the suppliers' tax clearance on SARS as well as the Central Suppliers Database, **the quote will not be considered and passed over as non-compliant according to National Treasury Instruction Note 4 (a) 2016/17.**

## 11. TAX INVOICE

11.1. A tax invoice shall be in the currency of the Republic of South Africa and shall contain the following particulars:

- (i) the name, address and registration number of the supplier;
- (ii) the name and address of the recipient;
- (iii) an individual serialized number and the date upon which the tax invoice is issued;
- (iv) a description and quantity or volume of the goods or services supplied;
- (v) the official department order number issued to the supplier;
- (vi) the value of the supply, the amount of tax charged;
- (vii) the words tax invoice in a prominent place.

## 12. PATENT RIGHTS

The supplier shall indemnify the **KZN Department of Health** (hereafter known as the purchaser) against all third-party claims of infringement of patent, trademark, or industrial design rights arising from use of the goods or any part thereof by the purchaser.

## 13. PENALTIES

- 13.1. If at any time during the contract period, the service provider is unable to perform in a timely manner, the service provider must notify the institution in writing/email of the cause of and the duration of the delay. Upon receipt of the notification, the institution should evaluate the circumstances and, if deemed necessary, the institution may extend the service provider's time for performance.
- 13.2. In the event of delayed performance that extends beyond the delivery period, the institution is entitled to purchase commodities of a similar quantity and quality as a substitution for the outstanding commodities, without terminating the contract, as well as return commodities delivered at a later stage at the service provider's expense.
- 13.3. Alternatively, the institution may elect to terminate the contract and procure the necessary commodities in order to complete the contract. In the event that the contract is terminated the institution may claim damages from the service provider in the form of a penalty. The service provider's performance should be captured on the service provider database in order to determine whether or not the service provider should be awarded any contracts in the future.
- 13.4. If the supplier fails to deliver any or all of the goods or to perform the services within the period(s) specified in the contract, the purchaser shall, without prejudice to its other remedies under the contract, deduct from the contract price, as a penalty, a sum calculated on the delivered price of the delayed goods or unperformed services using the current prime interest rate calculated for each day of the delay until actual delivery or performance.

## 14. TERMINATION FOR DEFAULT

- 14.1. The purchaser, without prejudice to any other remedy for breach of contract, by written notice of default sent to the supplier, may terminate this contract in whole or in part:
  - (i) if the supplier fails to deliver any or all of the goods within the period(s) specified in the contract,
  - (ii) if the supplier fails to perform any other obligation(s) under the contract; or
  - (iii) if the supplier, in the judgment of the purchaser, has engaged in corrupt or fraudulent practices in competing for or in executing the contract.
- 14.2. In the event the purchaser terminates the contract in whole or in part, the purchaser may procure, upon such terms and in such manner as it deems appropriate, goods, works or services similar to those undelivered, and the supplier shall be liable to the purchaser for any excess costs for such similar goods, works or services.
- 14.3. Where the purchaser terminates the contract in whole or in part, the purchaser may decide to impose a restriction penalty on the supplier by prohibiting such supplier from doing business with the public sector for a period not exceeding 10 years.

## 15. FAILURE TO COMPLY WITH ABOVE WILL RESULT IN YOUR QUOTE BEING PASSED OVER.

**PREFERENCE POINTS CLAIM FORM IN TERMS OF THE PREFERENTIAL PROCUREMENT REGULATIONS 2017**

This preference form must form part of all quotes invited. It contains general information and serves as a claim form for preference points for Broad-Based Black Economic Empowerment (B-BBEE) Status Level of Contribution

**NB: BEFORE COMPLETING THIS FORM, BIDDERS MUST STUDY THE GENERAL CONDITIONS, DEFINITIONS AND DIRECTIVES APPLICABLE IN RESPECT OF B-BBEE, AS PRESCRIBED IN THE PREFERENTIAL PROCUREMENT REGULATIONS, 2017.**

**1. GENERAL CONDITIONS**

1.1 The following preference point systems are applicable to all quotes:

- the 80/20 system for requirements with a Rand value of up to R50 000 000 (all applicable taxes included); and

1.2 The value of this quote is estimated to not exceed R50 000 000 (all applicable taxes included) and therefore the 80/20 preference point system shall be applicable.

1.3 Points for this quote shall be awarded for:

- (a) Price; and
- (b) B-BBEE Status Level of Contributor.

1.4 The maximum points for this quote is allocated as follows:

	<b>POINTS</b>
<b>PRICE</b>	80
<b>B-BBEE STATUS LEVEL OF CONTRIBUTOR</b>	20
<b>Total points for Price and B-BBEE must not exceed</b>	<b>100</b>

1.5 Failure on the part of a bidder to submit proof of B-BBEE Status level of contributor together with the quote, will be interpreted to mean that preference points for B-BBEE status level of contribution are not claimed.

1.6 The purchaser reserves the right to require of a bidder, either before a quote is adjudicated or at any time subsequently, to substantiate any claim in regard to preferences, in any manner required by the purchaser.

**2. DEFINITIONS**

- (a) **"B-BBEE"** means broad-based black economic empowerment as defined in section 1 of the Broad-Based Black Economic Empowerment Act;
- (b) **"B-BBEE status level of contributor"** means the B-BBEE status of an entity in terms of a code of good practice on black economic empowerment, issued in terms of section 9(1) of the Broad-Based Black Economic Empowerment Act;
- (c) **"bid"** means a written offer in a prescribed or stipulated form in response to an invitation by an organ of state for the provision of goods or services, through price quotations, advertised competitive bidding processes or proposals;
- (d) **"Broad-Based Black Economic Empowerment Act"** means the Broad-Based Black Economic Empowerment Act, 2003 (Act No. 53 of 2003);
- (e) **"EME"** means an Exempted Micro Enterprise in terms of a code of good practice on black economic empowerment issued in terms of section 9 (1) of the Broad-Based Black Economic Empowerment Act;
- (f) **"functionality"** means the ability of a tenderer to provide goods or services in accordance with specifications as set out in the tender documents.
- (g) **"prices"** includes all applicable taxes less all unconditional discounts;
- (h) **"proof of B-BBEE status level of contributor"** means:
  - 1) B-BBEE Status level certificate issued by an authorized body or person;
  - 2) A sworn affidavit as prescribed by the B-BBEE Codes of Good Practice;
  - 3) Any other requirement prescribed in terms of the B-BBEE Act;
- (i) **"QSE"** means a qualifying small business enterprise in terms of a code of good practice on black economic empowerment issued in terms of section 9 (1) of the Broad-Based Black Economic Empowerment Act;
- (j) **"rand value"** means the total estimated value of a contract in Rand, calculated at the time of bid invitation, and includes all applicable taxes;



**3. POINTS AWARDED FOR PRICE**

**3.1 THE 80/20 PREFERENCE POINT SYSTEMS**

A maximum of 80 points is allocated for price on the following basis:

$$P_s = 80 \left( 1 - \frac{P_t - P_{\min}}{P_{\min}} \right) \text{ Where}$$

- Ps = Points scored for price of bid under consideration
- Pt = Price of bid under consideration
- Pmin = price of lowest acceptable bid

**4. POINTS AWARDED FOR B-BBEE STATUS LEVEL OF CONTRIBUTOR**

4.1 In terms of Regulation 6 (2) and 7 (2) of the Preferential Procurement Regulations, preference points must be awarded to a bidder for attaining the B-BBEE status level of contribution in accordance with the table below:

B-BBEE Status Level of Contributor	Number of points (80/20 system)
1	20
2	18
3	14
4	12
5	8
6	6
7	4
8	2
Non-compliant contributor	0

**5. BID DECLARATION**

5.1 Bidders who claim points in respect of B-BBEE Status Level of Contribution must complete the following:

**6. B-BBEE STATUS LEVEL OF CONTRIBUTOR CLAIMED IN TERMS OF PARAGRAPHS 1.4 AND 4.1**

6.1 B-BBEE Status Level of Contributor: = .....(maximum of 20 points)

(Points claimed in respect of paragraph 7.1 must be in accordance with the table reflected in paragraph 4.1 and must be substantiated by relevant proof of B-BBEE status level of contributor.

**7. SUB-CONTRACTING**  
(applicable box)

(Tick

YES		NO	
-----	--	----	--

7.1 Will any portion of the contract be sub-contracted?

7.1.1 If yes, indicate:

- i) What percentage of the contract will be subcontracted.....%
- ii) The name of the sub-contractor.....
- iii) The B-BBEE status level of the sub-contractor.....

8. Whether the sub-contractor is an EME or QSE

(Tick applicable box)

iv) Specify, by ticking the appropriate box, if subcontracting with an enterprise in terms of Preferential Procurement Regulations,2017:

YES		NO	
-----	--	----	--

Designated Group: An EME or QSE which is at last 51% owned by:	EME √	QSE √
Black people		
Black people who are youth		
Black people who are women		
Black people with disabilities		
Black people living in rural or underdeveloped areas or townships		
Cooperative owned by black people		
Black people who are military veterans		
OR		
Any EME		

Any QSE		
---------	--	--

9. **DECLARATION WITH REGARD TO COMPANY/FIRM**

9.1 Name of company/firm:.....

9.2 VAT registration number:.....

9.3 Company registration number:.....

9.4 **TYPE OF COMPANY/ FIRM [TICK APPLICABLE BOX]**

- Partnership/Joint Venture / Consortium
- One person business/sole propriety
- Close corporation
- Company
- (Pty) Limited

9.5 **DESCRIBE PRINCIPAL BUSINESS ACTIVITIES**

.....  
 .....

9.6 **COMPANY CLASSIFICATION [TICK APPLICABLE BOX]**

- Manufacturer
- Supplier
- Professional service provider
- Other service providers, e.g. transporter, etc.

9.7 Total number of years the company/firm has been in business:.....

9.8 I/we, the undersigned, who is / are duly authorised to do so on behalf of the company/firm, certify that the points claimed, based on the B-BBE status level of contributor indicated in paragraphs 1.4 and 6.1 of the foregoing certificate, qualifies the company/ firm for the preference(s) shown and I / we acknowledge that:

- i) The information furnished is true and correct;
- ii) The preference points claimed are in accordance with the General Conditions as indicated in paragraph 1 of this form;
- iii) In the event of a contract being awarded as a result of points claimed as shown in paragraphs 1.4 and 6.1, the contractor may be required to furnish documentary proof to the satisfaction of the purchaser that the claims are correct;
- iv) If the B-BBEE status level of contributor has been claimed or obtained on a fraudulent basis or any of the conditions of contract have not been fulfilled, the purchaser may, in addition to any other remedy it may have –
  - (a) disqualify the person from the bidding process;
  - (b) recover costs, losses or damages it has incurred or suffered as a result of that person's conduct;
  - (c) cancel the contract and claim any damages which it has suffered as a result of having to make less favourable arrangements due to such cancellation;
  - (d) recommend that the bidder or contractor, its shareholders and directors, or only the shareholders and directors who acted on a fraudulent basis, be restricted by the National Treasury from obtaining business from any organ of state for a period not exceeding 10 years, after the *audi alteram partem* (hear the other side) rule has been applied; and
  - (e) forward the matter for criminal prosecution.

<p>WITNESSES</p> <p>1. ....</p> <p>2. ....</p>
--

<p>.....          SIGNATURE(S) OF BIDDERS(S)</p> <p>DATE: .....</p> <p>ADDRESS.....          .....          .....</p>
---





**KWAZULU-NATAL PROVINCE**

HEALTH  
REPUBLIC OF SOUTH AFRICA

800 Belliar Road, Private Bag x 1B 4058  
Tel: 0312402868 Fax: 0312402880 Email: [eric.appelgryn@kznhealth.gov.za](mailto:eric.appelgryn@kznhealth.gov.za)  
[www.kznhealth.gov.za](http://www.kznhealth.gov.za)

Regional Laundry Cato Manor

**SPECIFICATION FOR MECHANICAL AND ELECTRICAL EQUIPMENT**

<u>Items Description</u>	<u>Quantity</u>	<u>Unit price</u>	<u>Total</u>
ANGLE GRINDER 750 Watt	1		
ANGLE GRINDER 1500 Watt	1		
BALL PIEN HAMMER 680 Grams	3		
BELT PUNCH SET	1		
CENTRE PUNCH SET	4		
DIGITAL INSULATION TESTER	1		
DRILL BITS STEEL HIGH SPEED SET	4		
DRILL DRIVER SET	1		
ELECTRICAL ROTARY IMPACT DRILLING MACHINE 750 Watt	1		
ELECTRICAL ROTARY HAMMER DRILLING MACHINE 1500 Watt	1		

ELECTRICIAN KIT		2	
ENGINEERS VICE 150 Millimetres		1	
EXTENSION ELECTRICAL CORD 30 METERS		2	
GASKET CUTTER		1	
HAMMER 2 POUND		1	
HAMMER 4 POUND		2	
MASONARY DRILL BIT SET		4	
PIN PUNCH SET		6	
RECHARGEABLE CORDLESS DRILLING MACHINE 18 Volt		1	
SCREWDRIVER INSULATED SET		3	
SHIFTING WRENCH 300 Millimeters		3	
SHIFTING WRENCH 350 Millimeters		3	
SPIRIT LEVEL 600 Millimeters		1	
TAP AND DIE SET		4	
TIN SNIP		1	
TOOLS 60 PIECE SET		3	
UTILITY KNIFE		3	
VOLT STICK		2	
HEAD TORCH PORTABLE RECHARGEABLE		3	

ELECTRICAL DIGITAL MULTIMETER	1		
ELECTRICAL SOCKET ELCB TESTER	1		
HOSE PIPE 20 Millimetres x 30 Metres	1		
STEP LADDER A-FRAME 8 STEP FIBREGLASS	1		
STEP LADDER A-FRAME 12 STEP ALUMINIUM	1		
PUMP ROTARY 210 Litre DRUM TYPE	1		
GARDEN SPADE	2		
FLOOR SCRAPER	2		
PUTTY SCRAPER	2		
WIRE BRUSH	1		
HACKSAW BLADE	10		
HACKSAW	1		
TOMMY BAR	1		
TORCH PORTABLE RECHARGEABLE	3		
WHEELBARROW	1		
		Vat 15%	
		Total	



**health**

Department:  
Health  
PROVINCE OF KWAZULU-NATAL

**DIRECTORATE:**

Physical Address 800 Bellair road, Durban ,4001  
Postal Address Private bag X18, Mayville ,4058  
Tel: 031 240 2866 Fax 031 240 2880 Email: tommy.terblanche@kznhealth.gov.za  
www.kznhealth.gov.za

Regional Laundry Cato Manor

**DATE: 12/11/2021**

**Specification: RLCM**

SPECIFICATION FOR: ANGLE GRINDER 750 Watt



NO.	SPECIFICATION	BIDDERS COMMENTS: STATE "COMPLIES" OR "DOES NOT COMPLY"	
Clause 1	Voltage:220-240V~50/60Hz.		
Clause 2	Input Power: 750 Watt.		
Clause 3	No-Load Speed:12000 Rpm.		
Clause 4	Disc Diameter: 115 millimeters.		
Clause 5	Spindle Thread: M14.		
Clause 6	Including Auxiliary Handle.		

BIDDER: \_\_\_\_\_

SIGNATURE: \_\_\_\_\_ DATE: \_\_\_\_\_

ADDRESS: \_\_\_\_\_

PHONE: \_\_\_\_\_ FAX: \_\_\_\_\_



**health**

Department:  
Health  
PROVINCE OF KWAZULU-NATAL

**DIRECTORATE:**

Physical Address 800 Bellair road, Durban ,4001  
Postal Address Private bag X18, Mayville ,4058  
Tel: 031 240 2866 Fax 031 240 2880 Email: tommy.terblanche@kznhealth.gov.za  
[www.kznhealth.gov.za](http://www.kznhealth.gov.za)

**Regional Laundry Cato Manor**

**DATE: 12/11/2021**

**Specification: RLCM**

**SPECIFICATION FOR: ANGLE GRINDER 1500 Watt**



<b>NO.</b>	<b>SPECIFICATION</b>	<b>BIDDERS COMMENTS: STATE "COMPLIES" OR "DOES NOT COMPLY"</b>	
<b>Clause 1</b>	Voltage:220-240V~50/60Hz.		
<b>Clause 2</b>	Input Power: 1500 Watt.		
<b>Clause 3</b>	No-load speed: 2.800 - 11.500 rpm.		
<b>Clause 4</b>	Disc Diameter: 125 millimeters.		
<b>Clause 5</b>	Spindle Thread: M14.		
<b>Clause 6</b>	Including Auxiliary Handle.		

BIDDER: \_\_\_\_\_

SIGNATURE: \_\_\_\_\_ DATE: \_\_\_\_\_

ADDRESS: \_\_\_\_\_

PHONE: \_\_\_\_\_ FAX: \_\_\_\_\_





**health**

Department:  
Health  
PROVINCE OF KWAZULU-NATAL

**DIRECTORATE:**

Physical Address 800 Bellair road, Durban, 4001  
Postal Address Private bag X18, Mayville, 4058  
Tel: 031 240 2866 Fax 031 240 2880 Email: tommy.terblanche@kznhealth.gov.za  
[www.kznhealth.gov.za](http://www.kznhealth.gov.za)

**Regional Laundry Cato Manor**

**DATE: 12/11/2021**

**Specification: RLCM**

**SPECIFICATION FOR: BALL PIEN HAMMER 680 Grams**

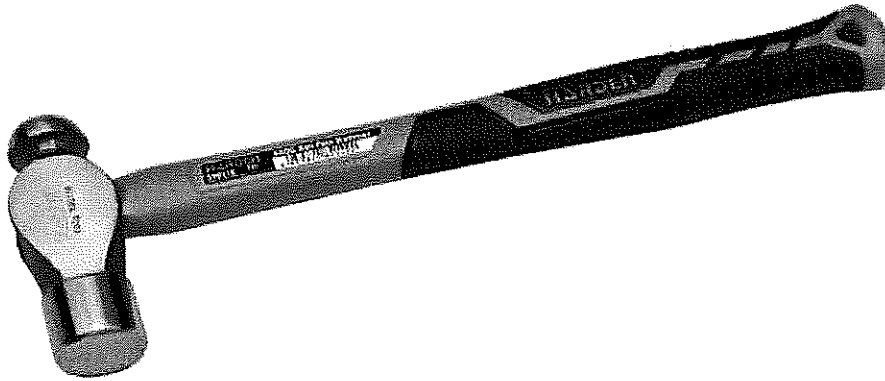

NO.	SPECIFICATION	BIDDERS COMMENTS: STATE "COMPLIES" OR "DOES NOT COMPLY"	
Clause 1	Weight 680 grams		
Clause 2	Forged fine grain steel.		
Clause 3	Fibreglass shaft.		
Clause 4	Comfortable ergonomic cushion grip.		
Clause 5	Striking face induction hard.		

BIDDER: \_\_\_\_\_

SIGNATURE: \_\_\_\_\_ DATE: \_\_\_\_\_

ADDRESS: \_\_\_\_\_

PHONE: \_\_\_\_\_ FAX: \_\_\_\_\_



**health**

Department:  
Health  
PROVINCE OF KWAZULU-NATAL

**DIRECTORATE:**

Physical Address 800 Bellair road, Durban ,4001  
Postal Address Private bag X18, Mayville ,4058  
Tel: 031 240 2866 Fax 031 240 2880 Email: tommy.terblanche@kznhealth.gov.za  
www.kznhealth.gov.za

**Regional Laundry Cato Manor**

**DATE: 12/11/2021**

**Specification: RLCM**

**SPECIFICATION FOR: BELT PUNCH SET**



NO.	SPECIFICATION	BIDDERS COMMENTS: STATE "COMPLIES" OR "DOES NOT COMPLY"	
<b>Clause 1</b>	Belt Punch Sizes 6 millimeters to 19 millimeters.		
<b>Clause 2</b>	A belt punch is a hole punch specifically for making holes in leather.		
<b>Clause 3</b>	6 Piece Hollow Steel Punches.		

BIDDER: \_\_\_\_\_

SIGNATURE: \_\_\_\_\_ DATE: \_\_\_\_\_

ADDRESS: \_\_\_\_\_

PHONE: \_\_\_\_\_ FAX: \_\_\_\_\_



**health**

Department:  
Health  
PROVINCE OF KWAZULU-NATAL

**DIRECTORATE:**

Physical Address 800 Bellair road, Durban ,4001  
Postal Address Private bag X18, Mayville ,4058  
Tel: 031 240 2866 Fax 031 240 2880 Email: tommy.terblanche@kznhealth.gov.za  
www.kznhealth.gov.za

**Regional Laundry Cato Manor**

**DATE: 12/11/2021**

**Specification: RLCM**

SPECIFICATION FOR: CENTRE PUNCH SET

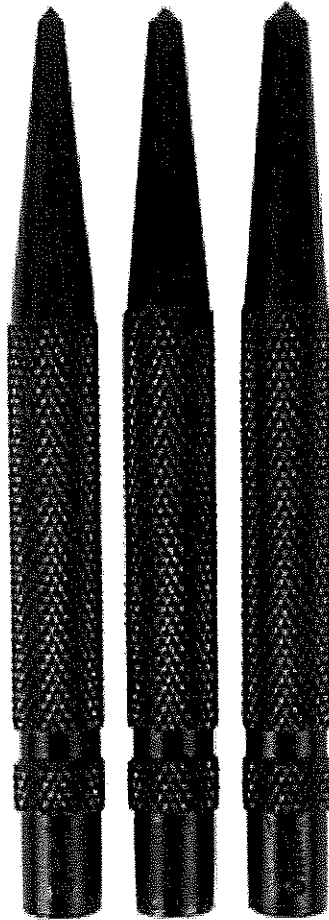

NO.	SPECIFICATION	BIDDERS COMMENTS: STATE "COMPLIES" OR "DOES NOT COMPLY"	
Clause 1	3 Piece Centre Punch Set.		
Clause 2	3/4/5 x 10 x 100 millimeters.		

BIDDER: \_\_\_\_\_

SIGNATURE: \_\_\_\_\_ DATE: \_\_\_\_\_

ADDRESS: \_\_\_\_\_

PHONE: \_\_\_\_\_ FAX: \_\_\_\_\_



**health**

Department:  
Health  
PROVINCE OF KWAZULU-NATAL

**DIRECTORATE:**

Physical Address 800 Bellair road, Durban ,4001  
Postal Address Private bag X18, Mayville ,4058  
Tel: 031 240 2866 Fax 031 240 2880 Email: tommy.terblanche@kznhealth.gov.za  
www.kznhealth.gov.za

**Regional Laundry Cato Manor**

**DATE: 12/11/2021**

**Specification: RLCM**

SPECIFICATION FOR: DIGITAL INSULATION TESTER



NO.	SPECIFICATION	BIDDERS COMMENTS: STATE "COMPLIES" OR "DOES NOT COMPLY"	
Clause 1	The K3005 has three test voltage ranges: 250V, 500V and 1000V and is equipped with a unique bar graph display.		
Clause 2	An advanced feature included is Auto Null mode, this unique function subtracts the test lead resistance during continuity tests, ensuring repeatable accuracy.		
Clause 3	Set test probes K7122.		
Clause 4	Strap Belt.		
Clause 5	Test probe pouch.		
Clause 6	AA Batteries X 8.		
Clause 7	Spare fuse F 500mA/600V.		

BIDDER: \_\_\_\_\_

SIGNATURE: \_\_\_\_\_ DATE: \_\_\_\_\_

ADDRESS: \_\_\_\_\_

\_\_\_\_\_

PHONE: \_\_\_\_\_ FAX: \_\_\_\_\_



**health**

Department:  
Health  
PROVINCE OF KWAZULU-NATAL

**DIRECTORATE:**

Physical Address 800 Bellair road, Durban ,4001  
Postal Address Private bag X18, Mayville ,4058  
Tel: 031 240 2866 Fax 031 240 2880 Email: tommy.terblanche@kznhealth.gov.za  
www.kznhealth.gov.za

**Regional Laundry Cato Manor**

**DATE: 12/11/2021**

**Specification: RLCM**

**SPECIFICATION FOR: DRILL BITS STEEL HIGH SPEED SET**

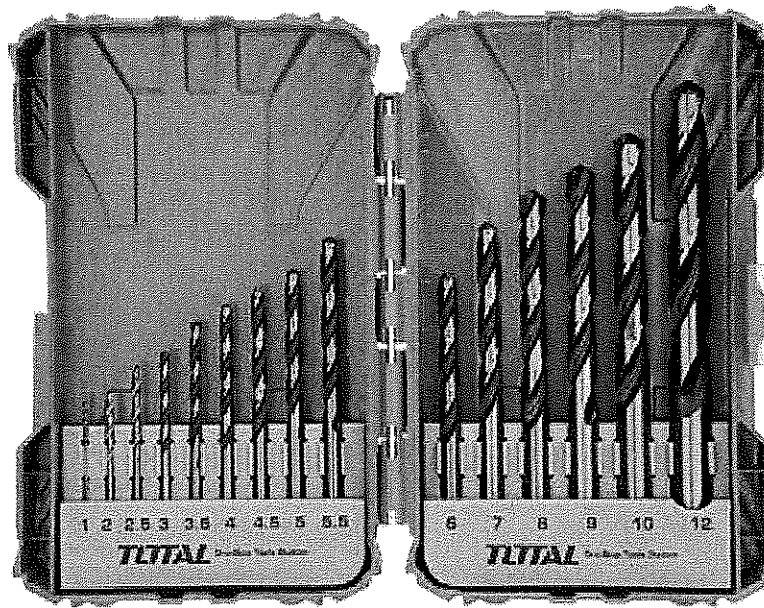

NO.	SPECIFICATION	BIDDERS COMMENTS: STATE "COMPLIES" OR "DOES NOT COMPLY"	
Clause 1	15 Piece High Speed Drill Bit Set.		
Clause 2	Sizes 1, 2, 2.5, 3, 3.5, 4, 4.5, 5, 5.5, 6, 7, 8, 9, 10, 12 millimeters.		
Clause 3	Including Storage Case.		

BIDDER: \_\_\_\_\_

SIGNATURE: \_\_\_\_\_ DATE: \_\_\_\_\_

ADDRESS: \_\_\_\_\_

PHONE: \_\_\_\_\_ FAX: \_\_\_\_\_



**health**

Department:  
Health  
PROVINCE OF KWAZULU-NATAL

**DIRECTORATE:**

Physical Address 800 Bellair road, Durban ,4001  
Postal Address Private bag X18, Mayville ,4058  
Tel: 031 240 2866 Fax 031 240 2880 Email: tommy.terblanche@kznhealth.gov.za  
www.kznhealth.gov.za

**Regional Laundry Cato Manor**

**DATE: 12/11/2021**

**Specification: RLCM**

**SPECIFICATION FOR: DRILL DRIVER SET 41 PIECE.**



NO.	SPECIFICATION	BIDDERS COMMENTS: STATE "COMPLIES" OR "DOES NOT COMPLY"	
Clause 1	x 1 Angle Driver.		
Clause 2	x 7 HSS-R Precision-ground metal drill bits.		
Clause 3	x 6 Masonry drill bits.		
Clause 4	x 5 Wood drill bits.		
Clause 5	x 2 Spade bits.		
Clause 6	x 11 Screwdriver bits.		
Clause 7	x 1 Magnetic universal holder.		
Clause 8	x 6 Nutsetters.		
Clause 9	x 1 Countersink and carry case.		
Clause 10	Including storage carry case.		

BIDDER: \_\_\_\_\_

SIGNATURE: \_\_\_\_\_ DATE: \_\_\_\_\_

ADDRESS: \_\_\_\_\_

\_\_\_\_\_

PHONE: \_\_\_\_\_ FAX: \_\_\_\_\_





**health**

Department:  
Health  
PROVINCE OF KWAZULU-NATAL

**DIRECTORATE:**

Physical Address 800 Bellair road, Durban ,4001  
Postal Address Private bag X18, Mayville ,4058  
Tel: 031 240 2866 Fax 031 240 2880 Email: tommy.terblanche@kznhealth.gov.za  
www.kznhealth.gov.za

Regional Laundry Cato Manor

**DATE: 12/11/2021**

**Specification: RLCM**

**SPECIFICATION FOR: ELECTRICAL ROTARY IMPACT DRILLING MACHINE 750 Watt**



NO.	SPECIFICATION	BIDDERS COMMENTS: STATE "COMPLIES" OR "DOES NOT COMPLY"	
Clause 1	Can drill in brick, concrete, stone, ceramic, steel, wood and plastic.		
Clause 2	Input Power: 750 Watt.		
Clause 3	No-Load Speed in 1st Gear: 0-3 000 rpm.		
Clause 4	Drill Spindle Connecting Thread: ½" – 20 UNF.		
Clause 5	Minimum Chuck Capacity: 1.5mm, Maximum Chuck Capacity: 13mm.		
Clause 6	Including storage carry case.		

BIDDER: \_\_\_\_\_

SIGNATURE: \_\_\_\_\_ DATE: \_\_\_\_\_

ADDRESS: \_\_\_\_\_

PHONE: \_\_\_\_\_ FAX: \_\_\_\_\_



**health**

Department:  
Health  
PROVINCE OF KWAZULU-NATAL

**DIRECTORATE:**

Physical Address 800 Bellair road, Durban ,4001  
Postal Address Private bag X18, Mayville ,4058  
Tel: 031 240 2866 Fax 031 240 2880 Email: tommy.terblanche@kznhealth.gov.za  
www.kznhealth.gov.za

**Regional Laundry Cato Manor**

**DATE: 12/11/2021**

**Specification: RLCM**

**SPECIFICATION FOR: ELECTRICAL DIGITAL MULTIMETER**



NO.	SPECIFICATION	BIDDERS COMMENTS: STATE "COMPLIES" OR "DOES NOT COMPLY"	
Clause 1	Category safety rating: IEC 1010-1: CAT I 1000 V, CAT II 600 V, CAT III 300 V.		
Clause 2	Automatic shutdown.		
Clause 3	Easily replaceable battery design.		
Clause 4	Voltage AC, Voltage DC, resistance, capacitance, continuity beeper, diode test, A ac, A dc all in a durable holster.		
Clause 5	Rugged and durable design – all inputs, ranges and functions are protected up to 1000 V		
Clause 6	Fluke Test Leads.		

BIDDER: \_\_\_\_\_

SIGNATURE: \_\_\_\_\_ DATE: \_\_\_\_\_

ADDRESS: \_\_\_\_\_

\_\_\_\_\_

PHONE: \_\_\_\_\_ FAX: \_\_\_\_\_



**health**

Department:  
Health  
PROVINCE OF KWAZULU-NATAL

**DIRECTORATE:**

Physical Address 800 Bellair road, Durban ,4001  
Postal Address Private bag X18, Mayville ,4058  
Tel: 031 240 2866 Fax 031 240 2880 Email: tommy.terblanche@kznhealth.gov.za  
www.kznhealth.gov.za

Regional Laundry Cato Manor

**DATE: 12/11/2021**

**Specification: RLCM**

**SPECIFICATION FOR: ELECTRICAL ROTARY HAMMER DRILL 1500 Watt**



NO.	SPECIFICATION	BIDDERS COMMENTS: STATE "COMPLIES" OR "DOES NOT COMPLY"	
Clause 1	Voltage:220-240V~50/60Hz.		
Clause 2	Input Power: 1500 Watt.		
Clause 3	No-Load Speed: 850 Rpm		
Clause 4	Impact rate: 4400 Bpm.		
Clause 5	Maximum drilling capacity: Concrete:32mm, Steel:13mm, Wood:40mm.		
Clause 6	Including storage carry case.		

BIDDER: \_\_\_\_\_

SIGNATURE: \_\_\_\_\_ DATE: \_\_\_\_\_

ADDRESS: \_\_\_\_\_

PHONE: \_\_\_\_\_ FAX: \_\_\_\_\_

BIDDER: \_\_\_\_\_

SIGNATURE: \_\_\_\_\_ DATE: \_\_\_\_\_

ADDRESS: \_\_\_\_\_

\_\_\_\_\_

PHONE: \_\_\_\_\_ FAX: \_\_\_\_\_



**health**

Department:  
Health  
PROVINCE OF KWAZULU-NATAL

**DIRECTORATE:**

Physical Address 800 Bellair road, Durban ,4001  
Postal Address Private bag X18, Mayville ,4058  
Tel: 031 240 2866 Fax 031 240 2880 Email: tommy.terblanche@kznhealth.gov.za  
www.kznhealth.gov.za

**Regional Laundry Cato Manor**

**DATE: 12/11/2021**

**Specification: RLCM**

**SPECIFICATION FOR: ELECTRICIAN KIT**



NO.	SPECIFICATION	BIDDERS COMMENTS: STATE "COMPLIES" OR "DOES NOT COMPLY"	
Clause 1	Digital Multimeter.		
Clause 2	165mm Combination Plier.		
Clause 3	165mm Diagonal Cutting Plier.		
Clause 4	170mm Long Nose Plier.		
Clause 5	110mm Precision Diagonal Cutter.		
Clause 6	125mm Precision Long Nose Plier.		
Clause 7	120mm Precision Combination Plier.		
Clause 8	Utility Knife.		
Clause 9	8 Piece Precision Screwdriver Set.		
Clause 10	Flat Screwdriver 6 millimeters tip. 200 millimeters Length.		
Clause 11	7 Piece 1000V Screwdriver Set.		
Clause 12	Include Kit Bag.		

BIDDER: \_\_\_\_\_

SIGNATURE: \_\_\_\_\_ DATE: \_\_\_\_\_

ADDRESS: \_\_\_\_\_

\_\_\_\_\_

PHONE: \_\_\_\_\_ FAX: \_\_\_\_\_



**health**

Department:  
Health  
PROVINCE OF KWAZULU-NATAL

**DIRECTORATE:**

Physical Address 800 Bellair road, Durban ,4001  
Postal Address Private bag X18, Mayville ,4058  
Tel: 031 240 2866 Fax 031 240 2880 Email: tommy.terblanche@kznhealth.gov.za  
www.kznhealth.gov.za

**Regional Laundry Cato Manor**

**DATE: 12/11/2021**

**Specification: RLCM**

**SPECIFICATION FOR: ENGINEERS VICE 150 Millimeters**

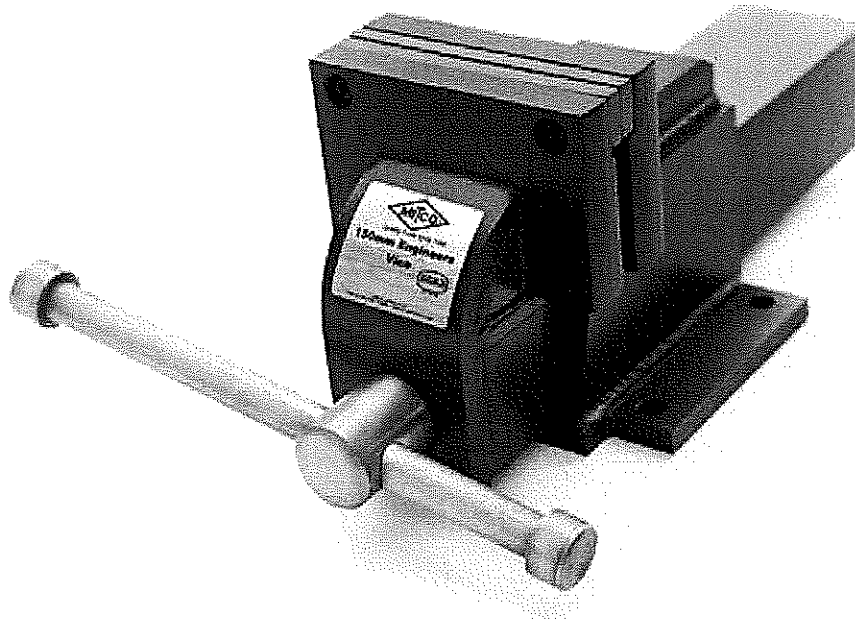

NO.	SPECIFICATION	BIDDERS COMMENTS: STATE "COMPLIES" OR "DOES NOT COMPLY"	
<b>Clause 1</b>	Size 150 millimeters.		
<b>Clause 2</b>	All steel construction.		
<b>Clause 3</b>	Bench type.		
<b>Clause 4</b>	Heavy duty industrial type.		

BIDDER: \_\_\_\_\_

SIGNATURE: \_\_\_\_\_ DATE: \_\_\_\_\_

ADDRESS: \_\_\_\_\_

PHONE: \_\_\_\_\_ FAX: \_\_\_\_\_





**health**

Department:  
Health  
PROVINCE OF KWAZULU-NATAL

**DIRECTORATE:**

Physical Address 800 Bellair road, Durban ,4001  
Postal Address Private bag X18, Mayville ,4058  
Tel: 031 240 2866 Fax 031 240 2880 Email: tommy.terblanche@kznhealth.gov.za  
www.kznhealth.gov.za

**Regional Laundry Cato Manor**

**DATE: 12/11/2021**

**Specification: RLCM**

**SPECIFICATION FOR: GASKET CUTTER**

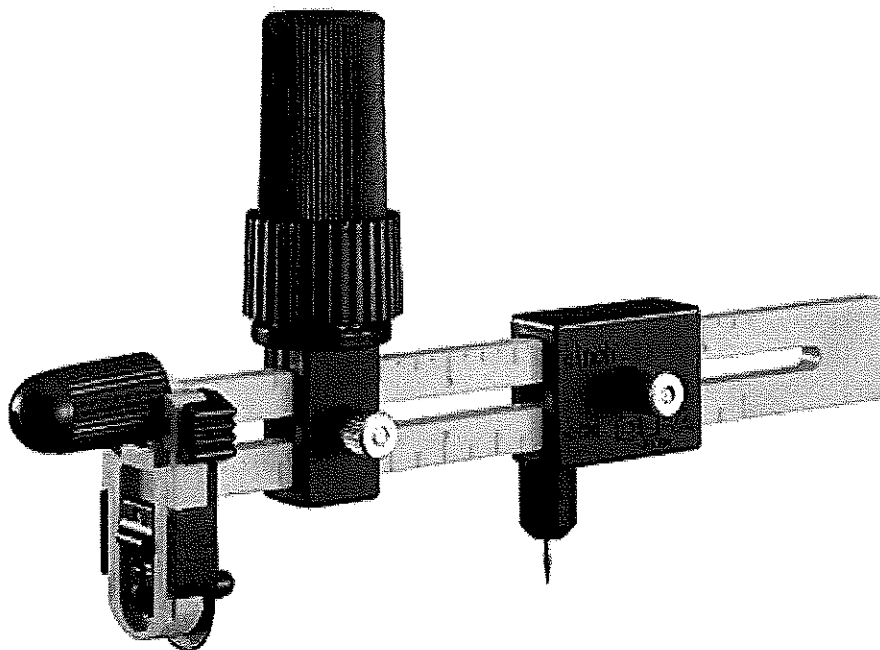

NO.	SPECIFICATION	BIDDERS COMMENTS: STATE "COMPLIES" OR "DOES NOT COMPLY"	
<b>Clause 1</b>	Compass cutter.		
<b>Clause 2</b>	18 millimeter rotary blade.		
<b>Clause 3</b>	Uses RB18 replacement blades.		
<b>Clause 4</b>	Works like a compass and cuts circles from 40 to 220 millimeters.		

BIDDER: \_\_\_\_\_

SIGNATURE: \_\_\_\_\_ DATE: \_\_\_\_\_

ADDRESS: \_\_\_\_\_

PHONE: \_\_\_\_\_ FAX: \_\_\_\_\_



**health**

Department:  
Health  
PROVINCE OF KWAZULU-NATAL

**DIRECTORATE:**

Physical Address 800 Bellair road, Durban ,4001  
Postal Address Private bag X18, Mayville ,4058  
Tel: 031 240 2866 Fax 031 240 2880 Email: tommy.terblanche@kznhealth.gov.za  
www.kznhealth.gov.za

**Regional Laundry Cato Manor**

**DATE: 12/11/2021**

**Specification: RLCM**

**SPECIFICATION FOR: HAMMER 2 POUND**



NO.	SPECIFICATION	BIDDERS COMMENTS: STATE "COMPLIES" OR "DOES NOT COMPLY"	
<b>Clause 1</b>	Forged steel powder-coated head.		
<b>Clause 2</b>	Precision-ground striking faces.		
<b>Clause 3</b>	Shock-absorbing fibreglass shaft with nylon surround.		
<b>Clause 4</b>	High-grip rubber handle.		
<b>Clause 5</b>	2 LB		

BIDDER: \_\_\_\_\_

SIGNATURE: \_\_\_\_\_ DATE: \_\_\_\_\_

ADDRESS: \_\_\_\_\_

PHONE: \_\_\_\_\_ FAX: \_\_\_\_\_



**health**

Department:  
Health  
PROVINCE OF KWAZULU-NATAL

**DIRECTORATE:**

Physical Address 800 Bellair road, Durban ,4001  
Postal Address Private bag X18, Mayville ,4058  
Tel: 031 240 2866 Fax 031 240 2880 Email: tommy.terblanche@kznhealth.gov.za  
www.kznhealth.gov.za

**Regional Laundry Cato Manor**

**DATE: 12/11/2021**

**Specification: RLCM**

**SPECIFICATION FOR: HAMMER 4 POUND (1,8KG)**



NO.	SPECIFICATION	BIDDERS COMMENTS: STATE "COMPLIES" OR "DOES NOT COMPLY"	
Clause 1	Forged steel powder-coated head.		
Clause 2	Precision-ground striking faces.		
Clause 3	Shock-absorbing fibreglass shaft with nylon surround.		
Clause 4	High-grip rubber handle.		
Clause 5	4lb (1.81 kg).		

BIDDER: \_\_\_\_\_

SIGNATURE: \_\_\_\_\_ DATE: \_\_\_\_\_

ADDRESS: \_\_\_\_\_

PHONE: \_\_\_\_\_ FAX: \_\_\_\_\_



**health**

Department:  
Health  
PROVINCE OF KWAZULU-NATAL

**DIRECTORATE:**

Physical Address 800 Bellair road, Durban ,4001  
Postal Address Private bag X18, Mayville ,4058  
Tel: 031 240 2866 Fax 031 240 2880 Email: tommy.terblanche@kznhealth.gov.za  
[www.kznhealth.gov.za](http://www.kznhealth.gov.za)

Regional Laundry Cato Manor

**DATE: 12/11/2021**

**Specification: RLCM**

SPECIFICATION FOR: MASONARY DRILL BIT SET



NO.	SPECIFICATION	BIDDERS COMMENTS: STATE "COMPLIES" OR "DOES NOT COMPLY"	
Clause 1	16 Piece.		
Clause 2	3mm x 2, 4mm x 2, 5, 6, 7, 8, 9, 10, 11, 12, 13, 14, 15, 16 millimeters.		
Clause 3	Tungsten Carbide Tipped (TCT).		
Clause 4	Including storage case.		

BIDDER: \_\_\_\_\_

SIGNATURE: \_\_\_\_\_ DATE: \_\_\_\_\_

ADDRESS: \_\_\_\_\_

PHONE: \_\_\_\_\_ FAX: \_\_\_\_\_



**health**

Department:  
Health  
PROVINCE OF KWAZULU-NATAL

**DIRECTORATE:**

Physical Address 800 Bellair road, Durban ,4001  
Postal Address Private bag X18, Mayville ,4058  
Tel: 031 240 2866 Fax 031 240 2880 Email: tommy.terblanche@kznhealth.gov.za  
www.kznhealth.gov.za

Regional Laundry Cato Manor

**DATE: 12/11/2021**

**Specification: RLCM**

SPECIFICATION FOR: PIN PUNCH SET

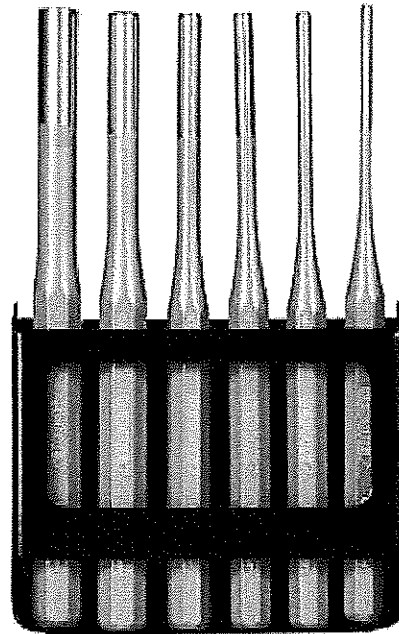
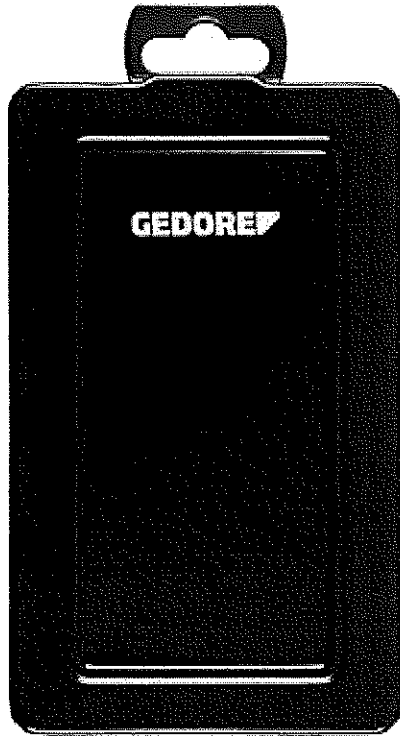

NO.	SPECIFICATION	BIDDERS COMMENTS: STATE "COMPLIES" OR "DOES NOT COMPLY"	
<b>Clause 1</b>	Hardened and tempered.		
<b>Clause 2</b>	Working edge polished.		
<b>Clause 3</b>	Sizes 3, 4, 5, 6, 8 and 10 millimeters,		
<b>Clause 4</b>	Including Storage Case.		
<b>Clause 5</b>	6 Piece.		

BIDDER: \_\_\_\_\_

SIGNATURE: \_\_\_\_\_ DATE: \_\_\_\_\_

ADDRESS: \_\_\_\_\_

PHONE: \_\_\_\_\_ FAX: \_\_\_\_\_



**health**

Department:  
Health  
PROVINCE OF KWAZULU-NATAL

**DIRECTORATE:**

Physical Address 800 Bellair road, Durban ,4001  
Postal Address Private bag X18, Mayville ,4058  
Tel: 031 240 2866 Fax 031 240 2880 Email: tommy.terblanche@kznhealth.gov.za  
www.kznhealth.gov.za

**Regional Laundry Cato Manor**

**DATE: 12/11/2021**

**Specification: RLCM**

**SPECIFICATION FOR: RECHARGABLE CORDLESS DRILLING MACHINE 18 VOLT**



NO.	SPECIFICATION	BIDDERS COMMENTS: STATE "COMPLIES" OR "DOES NOT COMPLY"	
Clause 1	Power Output: 18V Li-ion.		
Clause 2	Includes battery charger.		
Clause 3	Speed: 1900 rpm to 27000 rpm.		
Clause 4	Drill 35mm into Wood, 10 mm into Steel & 10mm into Masonry.		
Clause 5	Keyless chuck 13 millimeters.		
Clause 6	Includes storage carry case.		

BIDDER: \_\_\_\_\_

SIGNATURE: \_\_\_\_\_ DATE: \_\_\_\_\_

ADDRESS: \_\_\_\_\_

PHONE: \_\_\_\_\_ FAX: \_\_\_\_\_



**health**

Department:  
Health  
PROVINCE OF KWAZULU-NATAL

**DIRECTORATE:**

Physical Address 800 Bellair road, Durban ,4001  
Postal Address Private bag X18, Mayville ,4058  
Tel: 031 240 2866 Fax 031 240 2880 Email: tommy.terblanche@kznhealth.gov.za  
www.kznhealth.gov.za

Regional Laundry Cato Manor

**DATE: 12/11/2021**

**Specification: RLCM**

**SPECIFICATION FOR: SCREWDRIVER SET INSULATED 7 PIECE**

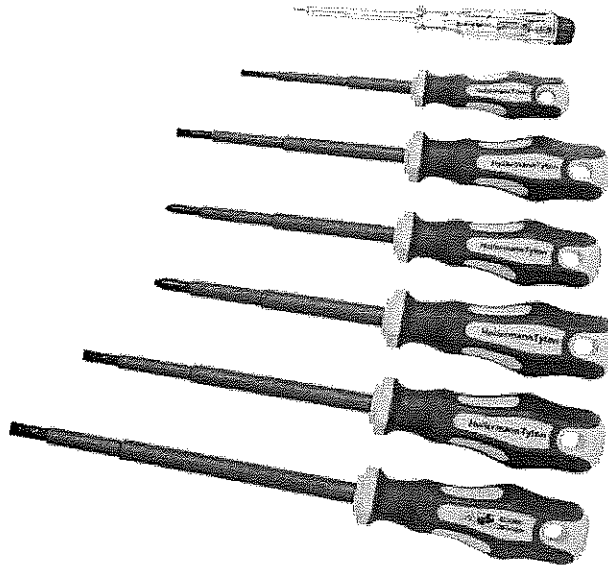

NO.	SPECIFICATION	BIDDERS COMMENTS: STATE "COMPLIES" OR "DOES NOT COMPLY"	
Clause 1	7 Piece including neon tester.		
Clause 2	Insulated - 1000V.		
Clause 3	Voltage tester range 100 - 250V.		
Clause 4	210mm Flat screwdriver (100mm head, 4mm (W) x 0.8 mm (T) tip).		
Clause 5	235mm Flat screwdriver (125mm head, 5.5mm (W) x 1mm (T) tip).		
Clause 6	260mm Flat screwdriver (150mm head, 6.5mm (W) x 1.2mm (T) tip).		
Clause 7	140mm Neon tester screwdriver (60mm head, 3mm (W) x 0.5mm (T) tip).		
Clause 8	165mm Phillips screwdriver (75mm head, 3mm (W) x PH0 (T) tip).		
Clause 9	210mm Phillips screwdriver (100mm head, 4mm (W) x PH1 (T) tip).		
Clause10	210mm Phillips screwdriver (100mm head, 6mm (W) x PH2 (T) tip).		

BIDDER: \_\_\_\_\_

SIGNATURE: \_\_\_\_\_ DATE: \_\_\_\_\_

ADDRESS: \_\_\_\_\_

PHONE: \_\_\_\_\_ FAX: \_\_\_\_\_



**health**

Department:  
Health  
PROVINCE OF KWAZULU-NATAL

**DIRECTORATE:**

Physical Address 800 Bellair road, Durban, 4001  
Postal Address Private bag X18, Mayville, 4058  
Tel: 031 240 2866 Fax 031 240 2880 Email: tommy.terblanche@kznhealth.gov.za  
www.kznhealth.gov.za

**Regional Laundry Cato Manor**

**DATE: 12/11/2021**

**Specification: RLCM**

**SPECIFICATION FOR: SHIFTING WRENCH 300mm**



NO.	SPECIFICATION	BIDDERS COMMENTS: STATE "COMPLIES" OR "DOES NOT COMPLY"	
Clause 1	Length 300 millimeters.		
Clause 2	Adjustable Wrench.		
Clause 3	Drop forged medium carbon steel body and jaw.		
Clause 4	Hardened, satin chrome plated and polished head.		

BIDDER: \_\_\_\_\_

SIGNATURE: \_\_\_\_\_ DATE: \_\_\_\_\_

ADDRESS: \_\_\_\_\_

PHONE: \_\_\_\_\_ FAX: \_\_\_\_\_





**health**

Department:  
Health  
PROVINCE OF KWAZULU-NATAL

**DIRECTORATE:**

Physical Address 800 Bellair road, Durban ,4001  
Postal Address Private bag X18, Mayville ,4058  
Tel: 031 240 2866 Fax 031 240 2880 Email: tommy.terblanche@kznhealth.gov.za  
www.kznhealth.gov.za

**Regional Laundry Cato Manor**

**DATE:**

**Specification:** RLCM

SPECIFICATION FOR: SHIFTING WRENCH 350mm

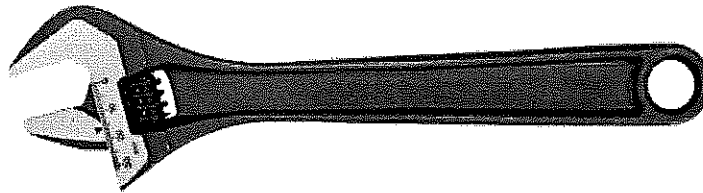

NO.	SPECIFICATION	BIDDERS COMMENTS: STATE "COMPLIES" OR "DOES NOT COMPLY"	
Clause 1	Length 350 millimeters.		
Clause 2	Adjustable Wrench.		
Clause 3	Drop forged medium carbon steel body and jaw.		
Clause 4	Hardened, satin chrome plated and polished head.		

BIDDER: \_\_\_\_\_

SIGNATURE: \_\_\_\_\_ DATE: \_\_\_\_\_

ADDRESS: \_\_\_\_\_

PHONE: \_\_\_\_\_ FAX: \_\_\_\_\_



**health**

Department:  
Health  
PROVINCE OF KWAZULU-NATAL

**DIRECTORATE:**

Physical Address 800 Bellair road, Durban ,4001  
Postal Address Private bag X18, Mayville ,4058  
Tel: 031 240 2866 Fax 031 240 2880 Email: tommy.terblanche@kznhealth.gov.za  
www.kznhealth.gov.za

**Regional Laundry Cato Manor**

**DATE: 12/11/2021**

**Specification: RLCM**

**SPECIFICATION FOR: SPIRIT LEVEL 600 Millimeters**

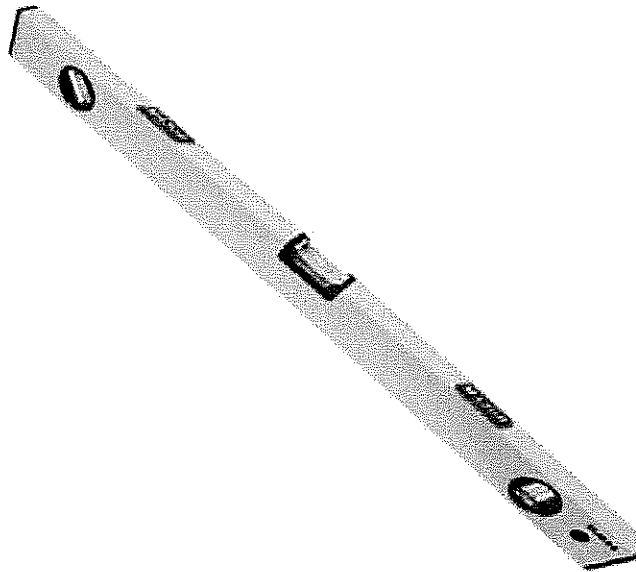

NO.	SPECIFICATION	BIDDERS COMMENTS: STATE "COMPLIES" OR "DOES NOT COMPLY"	
Clause 1	Length 600 millimeters.		
Clause 2	3 Way horizontal, vertical and 45 angle finding.		
Clause 3	Tough, hardened aluminium.		
Clause 4	Accuracy 0.5mm per 1 meter (0.0286) in normal position.		
Clause 5	Fixed all round viewing.		
Clause 6	Protective end caps.		
Clause 7	Shock resistant vials.		

BIDDER: \_\_\_\_\_

SIGNATURE: \_\_\_\_\_ DATE: \_\_\_\_\_

ADDRESS: \_\_\_\_\_

PHONE: \_\_\_\_\_ FAX: \_\_\_\_\_



**health**

Department:  
Health  
PROVINCE OF KWAZULU-NATAL

**DIRECTORATE:**

Physical Address 800 Bellair road, Durban ,4001  
Postal Address Private bag X18, Mayville ,4058  
Tel: 031 240 2866 Fax 031 240 2880 Email: tommy.terblanche@kznhealth.gov.za  
www.kznhealth.gov.za

**Regional Laundry Cato Manor**

**DATE: 12/11/2021**

**Specification: RLCM**

**SPECIFICATION FOR: TAP AND DIE SET**

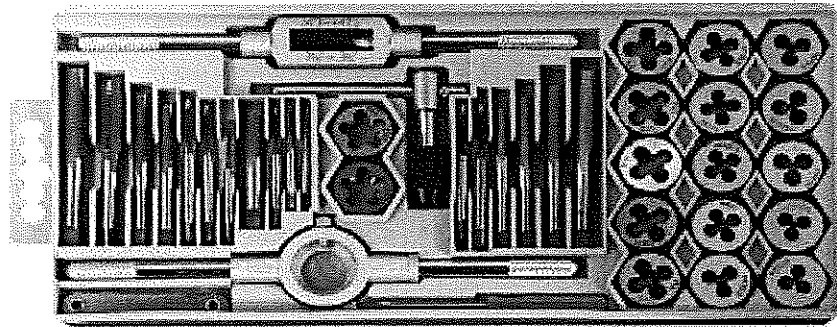

NO.	SPECIFICATION	BIDDERS COMMENTS: STATE "COMPLIES" OR "DOES NOT COMPLY"	
Clause 1	Sizes 3 millimeters to 12 millimeters.		
Clause 2	Cuts and renews external and internal threads to exacting standards.		
Clause 3	Heat treated and hardened.		
Clause 4	Precision ground.		
Clause 5	Carbon steel construction.		
Clause 6	Compartmentalized storage case.		
Clause 7	39 Piece.		
Clause 8	17 Taps, 17 Dies,		
Clause 9	Adjustable tap wrench, T-handle tap wrench, Adjustable die wrench.		
Clause 10	Screwdriver, Screw pitch gauge.		
Clause 11	Specifications: 4-36, 6-32, 8-32, 10-32, 10-24, 12-24, 1/4-20, 1/4-28, 5/16-18, 5/16-24, 3/8-16, 3/8-24, 7/16-30, 7/16-20, 1/2-13, and 1/2-20, 1/8 in. NPT.		

BIDDER: \_\_\_\_\_

SIGNATURE: \_\_\_\_\_ DATE: \_\_\_\_\_

ADDRESS: \_\_\_\_\_

\_\_\_\_\_

PHONE: \_\_\_\_\_ FAX: \_\_\_\_\_



**health**

Department:  
Health  
PROVINCE OF KWAZULU-NATAL

**DIRECTORATE:**

Physical Address 800 Bellair road, Durban ,4001  
Postal Address Private bag X18, Mayville ,4058  
Tel: 031 240 2866 Fax 031 240 2880 Email: tommy.terblanche@kznhealth.gov.za  
www.kznhealth.gov.za

Regional Laundry Cato Manor

**DATE: 12/11/2021**

**Specification: RLCM**

SPECIFICATION FOR: TIN SNIP



NO.	SPECIFICATION	BIDDERS COMMENTS: STATE "COMPLIES" OR "DOES NOT COMPLY"	
Clause 1	Length 250 millimeters.		
Clause 2	Professional Quality Steel Blades.		
Clause 3	With spring.		

BIDDER: \_\_\_\_\_

SIGNATURE: \_\_\_\_\_ DATE: \_\_\_\_\_

ADDRESS: \_\_\_\_\_

PHONE: \_\_\_\_\_ FAX: \_\_\_\_\_



**health**

Department:  
Health  
PROVINCE OF KWAZULU-NATAL

**DIRECTORATE:**

Physical Address 800 Bellair road, Durban ,4001  
Postal Address Private bag X18, Mayville ,4058  
Tel: 031 240 2866 Fax 031 240 2880 Email: tommy.terblanche@kznhealth.gov.za  
www.kznhealth.gov.za

Regional Laundry Cato Manor

**DATE: 12/11/2021**

**Specification: RLCM**

**SPECIFICATION FOR: TOOLS ASSORTMENT 60 PIECE WITH TOOL BOX**

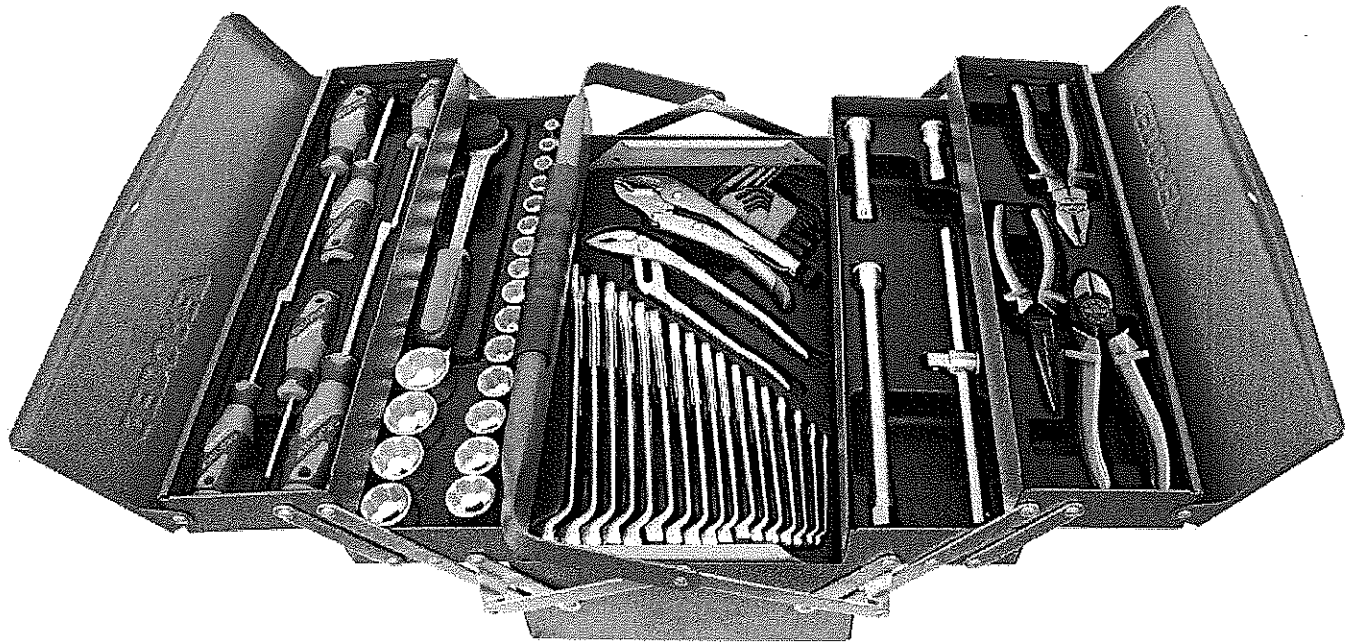

NO.	SPECIFICATION	BIDDERS COMMENTS: STATE "COMPLIES" OR "DOES NOT COMPLY"	
<b>Clause 1</b>	Combination Spanner sizes 6 millimeters to 22 millimeters. 17 pieces.		
<b>Clause 2</b>	Screwdrivers (4 slotted, 2 cross-head). 6 pieces.		
<b>Clause 3</b>	Sockets sizes 8 millimeters to 22 millimeters. 19 pieces.		
<b>Clause 4</b>	Allen Key set L-Shape. Sizes 3 millimeters to 14 millimeters. 8 pieces.		
<b>Clause 5</b>	Universal Pliers (Water Pump Pliers) Length 250 millimeters.		
<b>Clause 6</b>	Self-Grip Locking Pliers (Vice Grip) Length 250 millimeters.		
<b>Clause 7</b>	Combination Pliers Length 200 millimeters. Insulated handles.		
<b>Clause 8</b>	Long Nose Pliers Length 200 millimeters. Insulated handles.		
<b>Clause 9</b>	Side Cutters Length 160 millimeters. Insulated handles.		
<b>Clause 10</b>	½" Drive Socket Extension Length 75 millimeters.		
<b>Clause 11</b>	½" Drive Socket Extension Length 125 millimeters.		
<b>Clause 12</b>	½" Drive Socket Extension Length 250 millimeters.		
<b>Clause 13</b>	½" Drive Sliding T-Bar.		
<b>Clause 14</b>	½" Drive Ratchet with Coupler.		
<b>Clause 15</b>	Tool Box Complete with relevant compartments and indentations for holding all tools from Clause 1 to Clause 14. Lockable.		

BIDDER: \_\_\_\_\_

SIGNATURE: \_\_\_\_\_ DATE: \_\_\_\_\_

ADDRESS: \_\_\_\_\_

\_\_\_\_\_

PHONE: \_\_\_\_\_ FAX: \_\_\_\_\_



**health**

Department:  
Health  
PROVINCE OF KWAZULU-NATAL

**DIRECTORATE:**

Physical Address 800 Bellair road, Durban ,4001  
Postal Address Private bag X18, Mayville ,4058  
Tel: 031 240 2866 Fax 031 240 2880 Email: tommy.terblanche@kznhealth.gov.za  
www.kznhealth.gov.za

**Regional Laundry Cato Manor**

**DATE: 12/11/2021**

**Specification: RLCM**

**SPECIFICATION FOR: UTILITY KNIFE**

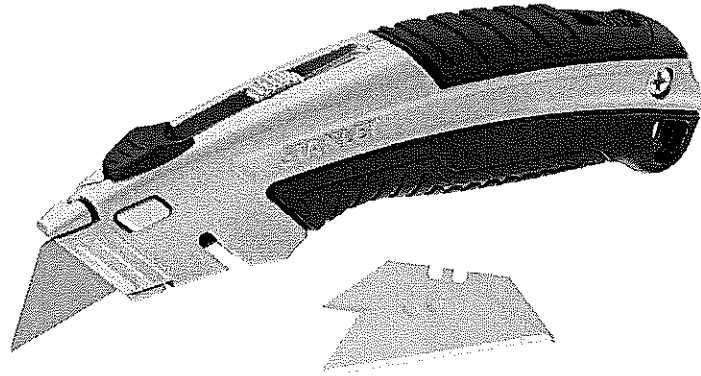

NO.	SPECIFICATION	BIDDERS COMMENTS: STATE "COMPLIES" OR "DOES NOT COMPLY"	
Clause 1	Narrow nose for better grip.		
Clause 2	Interlocking nose to hold blade securely.		
Clause 3	Retractable.		

BIDDER: \_\_\_\_\_

SIGNATURE: \_\_\_\_\_ DATE: \_\_\_\_\_

ADDRESS: \_\_\_\_\_

\_\_\_\_\_

PHONE: \_\_\_\_\_ FAX: \_\_\_\_\_





**health**

Department:  
Health  
PROVINCE OF KWAZULU-NATAL

**DIRECTORATE:**

Physical Address 800 Bellair road, Durban ,4001  
Postal Address Private bag X18, Mayville ,4058  
Tel: 031 240 2866 Fax 031 240 2880 Email: tommy.terblanche@kznhealth.gov.za  
www.kznhealth.gov.za

**Regional Laundry Cato Manor**

**DATE:**

**Specification:** RLCM

SPECIFICATION FOR: VOLTAGE DETECTOR STICK

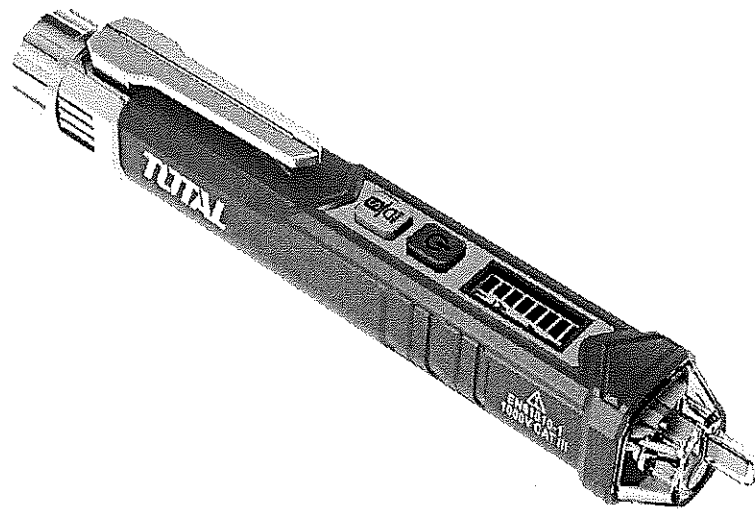

NO.	SPECIFICATION	BIDDERS COMMENTS: STATE "COMPLIES" OR "DOES NOT COMPLY"	
Clause 1	AC Voltage: 12V~1000V(High sensitivity) 48~1000V(Low sensitivity).		
Clause 2	Frequency:50/60Hz.		
Clause 3	Alarm mode: Sound and light alarm.		
Clause 4	Flash light : White LED Low battery indication.		
Clause 5	Auto power off.		
Clause 6	Auto distinguish the Live line and Netural line Packed by double blister.		

BIDDER: \_\_\_\_\_

SIGNATURE: \_\_\_\_\_ DATE: \_\_\_\_\_

ADDRESS: \_\_\_\_\_

PHONE: \_\_\_\_\_ FAX: \_\_\_\_\_



**health**

Department:  
Health  
PROVINCE OF KWAZULU-NATAL

**DIRECTORATE:**

Physical Address 800 Bellair road, Durban ,4001  
Postal Address Private bag X18, Mayville ,4058  
Tel: 031 240 2866 Fax 031 240 2880 Email: tommy.terblanche@kznhealth.gov.za  
www.kznhealth.gov.za

**Regional Laundry Cato Manor**

**DATE: 12/11/2021**

**Specification: RLCM**

SPECIFICATION FOR: HEAD TORCH LED RECHARGEABLE

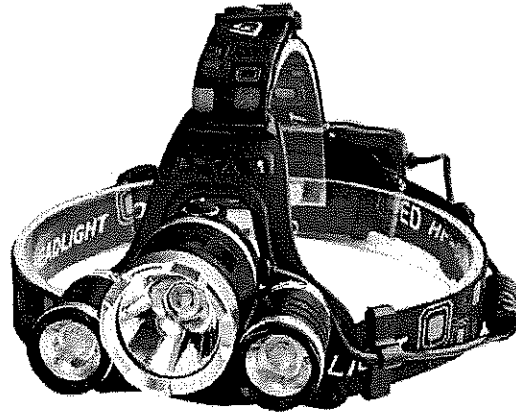

NO.	SPECIFICATION	BIDDERS COMMENTS: STATE "COMPLIES" OR "DOES NOT COMPLY"	
Clause 1	LED Quantity: 3		
Clause 2	Weatherproof.		
Clause 3	Adjustable Head Strap.		
Clause 4	Power Source: 2 x 18650 Batteries.		
Clause 5	Rechargeable with charger.		

BIDDER: \_\_\_\_\_

SIGNATURE: \_\_\_\_\_ DATE: \_\_\_\_\_

ADDRESS: \_\_\_\_\_

PHONE: \_\_\_\_\_ FAX: \_\_\_\_\_



**health**

Department:  
Health  
PROVINCE OF KWAZULU-NATAL

**DIRECTORATE:**

Physical Address 800 Bellair road, Durban ,4001  
Postal Address Private bag X18, Mayville ,4058  
Tel: 031 240 2866 Fax 031 240 2880 Email: tommy.terblanche@kznhealth.gov.za  
www.kznhealth.gov.za

**Regional Laundry Cato Manor**

**DATE: 12/11/2021**

**Specification: RLCM**

SPECIFICATION FOR: HOSE PIPE 20 Millimetres x 30 Metres



NO.	SPECIFICATION	BIDDERS COMMENTS: STATE "COMPLIES" OR "DOES NOT COMPLY"	
Clause 1	20 millimeter x 30 meters.		
Clause 2	Ribbed outer that provides excellent abrasion resistance.		
Clause 3	Minimum burst pressure – 2500kpa.		

BIDDER: \_\_\_\_\_

SIGNATURE: \_\_\_\_\_ DATE: \_\_\_\_\_

ADDRESS: \_\_\_\_\_

PHONE: \_\_\_\_\_ FAX: \_\_\_\_\_



**health**

Department:  
Health  
PROVINCE OF KWAZULU-NATAL

**DIRECTORATE:**

Physical Address 800 Bellair road, Durban ,4001  
Postal Address Private bag X18, Mayville ,4058  
Tel: 031 240 2866 Fax 031 240 2880 Email: tommy.terblanche@kznhealth.gov.za  
[www.kznhealth.gov.za](http://www.kznhealth.gov.za)

**Regional Laundry Cato Manor**

**DATE: 12/11/2021**

**Specification: RLCM**

**SPECIFICATION FOR: STEP LADDER A-FRAME 8 STEP FIBREGLASS**



NO.	SPECIFICATION	BIDDERS COMMENTS: STATE "COMPLIES" OR "DOES NOT COMPLY"	
Clause 1	Fiberglass.		
Clause 2	Heavy-duty non-conductive.		
Clause 3	75 Millimetres wide aluminum tread.		
Clause 4	Height 2,4 Meters.		
Clause 5	Maximum Static Vertical Load 150KG.		

BIDDER: \_\_\_\_\_

SIGNATURE: \_\_\_\_\_ DATE: \_\_\_\_\_

ADDRESS: \_\_\_\_\_

\_\_\_\_\_

PHONE: \_\_\_\_\_ FAX: \_\_\_\_\_



**health**

Department:  
Health  
PROVINCE OF KWAZULU-NATAL

**DIRECTORATE:**

Physical Address 800 Bellair road, Durban ,4001  
Postal Address Private bag X18, Mayville ,4058  
Tel. 031 240 2866 Fax 031 240 2880 Email: tommy.terblanche@kznhealth.gov.za  
www.kznhealth.gov.za

**Regional Laundry Cato Manor**

**DATE: 12/11/2021**

**Specification: RLCM**

**SPECIFICATION FOR: STEP LADDER A-FRAME 12 STEP ALUMINIUM**

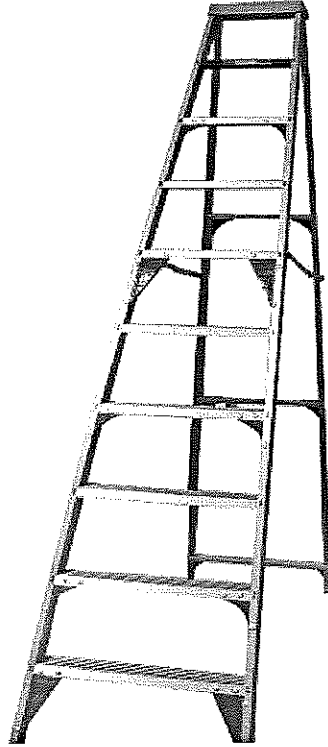

NO.	SPECIFICATION	BIDDERS COMMENTS: STATE "COMPLIES" OR "DOES NOT COMPLY"	
<b>Clause 1</b>	Free standing.		
<b>Clause 2</b>	A-Frame.		
<b>Clause 3</b>	12 Step.		
<b>Clause 4</b>	Aluminium construction.		

BIDDER: \_\_\_\_\_

SIGNATURE: \_\_\_\_\_ DATE: \_\_\_\_\_

ADDRESS: \_\_\_\_\_

PHONE: \_\_\_\_\_ FAX: \_\_\_\_\_



**health**

Department:  
Health  
PROVINCE OF KWAZULU-NATAL

**DIRECTORATE:**

Physical Address 800 Bellair road, Durban ,4001  
Postal Address Private bag X18, Mayville ,4058  
Tel: 031 240 2866 Fax 031 240 2880 Email: tommy.terblanche@kznhealth.gov.za  
www.kznhealth.gov.za

Regional Laundry Cato Manor

**DATE: 12/11/2021**

**Specification: RLCM**

SPECIFICATION FOR: PUMP ROTARY 210 Litre DRUM TYPE

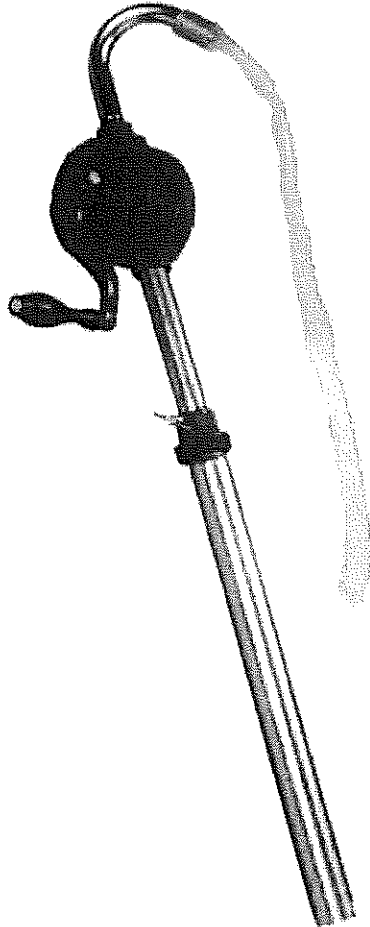

NO.	SPECIFICATION	BIDDERS COMMENTS: STATE "COMPLIES" OR "DOES NOT COMPLY"	
<b>Clause 1</b>	For 210L drums.		
<b>Clause 2</b>	Delivery – 105 Rotations = 20L.		
<b>Clause 3</b>	For oils, heavy fuels and non corrosive fluids.		

BIDDER: \_\_\_\_\_

SIGNATURE: \_\_\_\_\_ DATE: \_\_\_\_\_

ADDRESS: \_\_\_\_\_

PHONE: \_\_\_\_\_ FAX: \_\_\_\_\_



**health**

Department:  
Health  
PROVINCE OF KWAZULU-NATAL

**DIRECTORATE:**

Physical Address 800 Bellair road, Durban ,4001  
Postal Address Private bag X18, Mayville ,4058  
Tel: 031 240 2866 Fax 031 240 2880 Email: tommy.terblanche@kznhealth.gov.za  
www.kznhealth.gov.za

Regional Laundry Cato Manor

**DATE: 12/11/20121**

**Specification: RLCM**

SPECIFICATION FOR: GARDEN SPADE



NO.	SPECIFICATION	BIDDERS COMMENTS: STATE "COMPLIES" OR "DOES NOT COMPLY"	
<b>Clause 1</b>	Carbon steel hardened.		
<b>Clause 2</b>	Hardened/temperd-max strength.		
<b>Clause 3</b>	For digging.		
<b>Clause 4</b>	Square flat edge.		

BIDDER: \_\_\_\_\_

SIGNATURE: \_\_\_\_\_ DATE: \_\_\_\_\_

ADDRESS: \_\_\_\_\_

PHONE: \_\_\_\_\_ FAX: \_\_\_\_\_





**health**

Department:  
Health  
PROVINCE OF KWAZULU-NATAL

**DIRECTORATE:**

Physical Address 800 Bellair road, Durban ,4001  
Postal Address Private bag X18, Mayville ,4058  
Tel: 031 240 2866 Fax 031 240 2880 Email: tommy.terblanche@kznhealth.gov.za  
www.kznhealth.gov.za

Regional Laundry Cato Manor

**DATE: 12/11/2021**

**Specification: RLCM**

SPECIFICATION FOR: FLOOR SCRAPER



NO.	SPECIFICATION	BIDDERS COMMENTS: STATE "COMPLIES" OR "DOES NOT COMPLY"	
Clause 1	Width 300 millimeters.		
Clause 2	Including handle.		
Clause 3	Stainless steel.		

BIDDER: \_\_\_\_\_

SIGNATURE: \_\_\_\_\_ DATE: \_\_\_\_\_

ADDRESS: \_\_\_\_\_

PHONE: \_\_\_\_\_ FAX: \_\_\_\_\_



**health**

Department:  
Health  
PROVINCE OF KWAZULU-NATAL

**DIRECTORATE:**

Physical Address 800 Bellair road, Durban ,4001  
Postal Address Private bag X18, Mayville ,4058  
Tel: 031 240 2866 Fax 031 240 2880 Email: tommy.terblanche@kznhealth.gov.za  
www.kznhealth.gov.za

Regional Laundry Cato Manor

**DATE: 12/11/2021**

**Specification: RLCM**

**SPECIFICATION FOR: PUTTY SCRAPER**



NO.	SPECIFICATION	BIDDERS COMMENTS: STATE "COMPLIES" OR "DOES NOT COMPLY"	
Clause 1	Width 38 millimeters.		
Clause 2	Stainless Steel.		

BIDDER: \_\_\_\_\_

SIGNATURE: \_\_\_\_\_ DATE: \_\_\_\_\_

ADDRESS: \_\_\_\_\_

PHONE: \_\_\_\_\_ FAX: \_\_\_\_\_



**health**

Department:  
Health  
PROVINCE OF KWAZULU-NATAL

**DIRECTORATE:**

Physical Address 800 Bellair road, Durban ,4001  
Postal Address Private bag X18, Mayville ,4058  
Tel: 031 240 2866 Fax 031 240 2880 Email: tommy.terblanche@kznhealth.gov.za  
www.kznhealth.gov.za

**Regional Laundry Cato Manor**

**DATE: 12/11/2021**

**Specification: RLCM**

SPECIFICATION FOR: WIRE BRUSH



NO.	SPECIFICATION	BIDDERS COMMENTS: STATE "COMPLIES" OR "DOES NOT COMPLY"	
Clause 1	Length 300 millimeters.		
Clause 2	With handle.		
Clause 3	Fine bristle.		
Clause 4	Steel.		

BIDDER: \_\_\_\_\_

SIGNATURE: \_\_\_\_\_ DATE: \_\_\_\_\_

ADDRESS: \_\_\_\_\_

PHONE: \_\_\_\_\_ FAX: \_\_\_\_\_



**health**

Department:  
Health  
PROVINCE OF KWAZULU-NATAL

**DIRECTORATE:**

Physical Address 800 Bellair road, Durban ,4001  
Postal Address Private bag X18, Mayville ,4058  
Tel: 031 240 2866 Fax 031 240 2880 Email: tommy.terblanche@kznhealth.gov.za  
www.kznhealth.gov.za

**Regional Laundry Cato Manor**

**DATE: 12/11/2021**

**Specification: RLCM**

**SPECIFICATION FOR: HACKSAW BLADE**

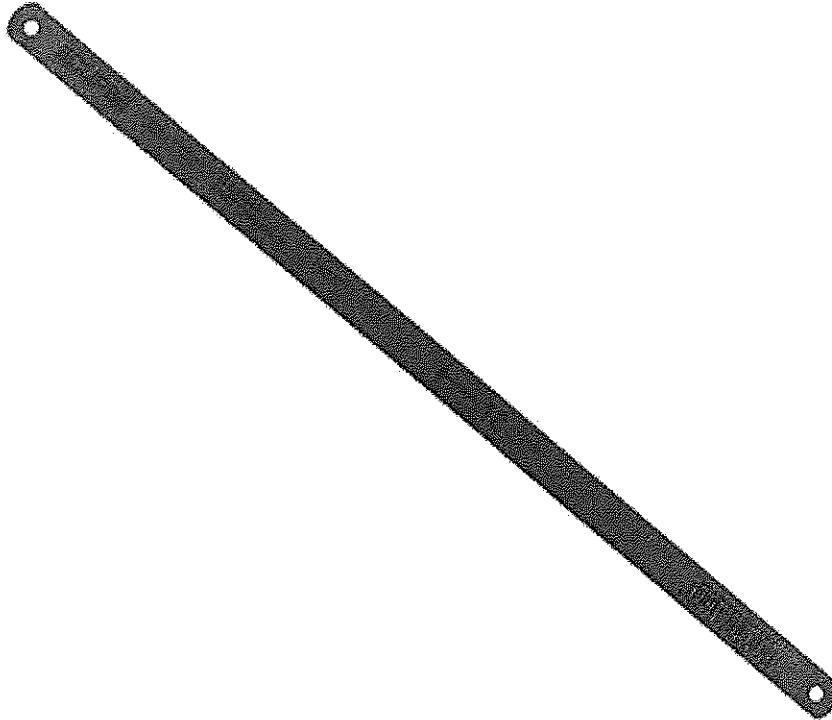

NO.	SPECIFICATION	BIDDERS COMMENTS: STATE "COMPLIES" OR "DOES NOT COMPLY"	
Clause 1	Length 300 millimeters.		
Clause 2	Shaterproof.		
Clause 3	24 Tpi.		
Clause 4	Pack of 10.		
Clause 5	Steel.		
Clause 6	Induction hardened along the teeth and edges only.		

BIDDER: \_\_\_\_\_

SIGNATURE: \_\_\_\_\_ DATE: \_\_\_\_\_

ADDRESS: \_\_\_\_\_

PHONE: \_\_\_\_\_ FAX: \_\_\_\_\_



**health**

Department:  
Health  
PROVINCE OF KWAZULU-NATAL

**DIRECTORATE:**

Physical Address 800 Bellair road, Durban ,4001  
Postal Address Private bag X18, Mayville ,4058  
Tel: 031 240 2866 Fax 031 240 2880 Email: tommy.terblanche@kznhealth.gov.za  
www.kznhealth.gov.za

**Regional Laundry Cato Manor**

**DATE: 12/11/2021**

**Specification: RLCM**

SPECIFICATION FOR: HACKSAW



NO.	SPECIFICATION	BIDDERS COMMENTS: STATE "COMPLIES" OR "DOES NOT COMPLY"	
Clause 1	Takes 300 millimeter blades.		
Clause 2	Adjustable to 45 or 90 degrees		
Clause 3	Saw blade can be rotated to 180 degrees for making angular & internal cuts.		

BIDDER: \_\_\_\_\_

SIGNATURE: \_\_\_\_\_ DATE: \_\_\_\_\_

ADDRESS: \_\_\_\_\_

PHONE: \_\_\_\_\_ FAX: \_\_\_\_\_



**health**

Department:  
Health  
PROVINCE OF KWAZULU-NATAL

**DIRECTORATE:**

Physical Address 800 Bellair road, Durban ,4001  
Postal Address Private bag X18, Mayville ,4058  
Tel: 031 240 2866 Fax 031 240 2880 Email: tommy.terblanche@kznhealth.gov.za  
www.kznhealth.gov.za

Regional Laundry Cato Manor

**DATE: 12/11/2021**

**Specification: RLCM**

SPECIFICATION FOR: TOMMY BAR



NO.	SPECIFICATION	BIDDERS COMMENTS: STATE "COMPLIES" OR "DOES NOT COMPLY"	
Clause 1	Length 600 millimeters.		
Clause 2	Chisel one end and tapered to point on the other end.		
Clause 3	The tapered end of a tommy bar is used as a marlinspike for the alignment of holes in steel construction work.		
Clause 4	Both ends off-set.		
Clause 5	It comes with an epoxy powder-coated finish.		

BIDDER: \_\_\_\_\_

SIGNATURE: \_\_\_\_\_ DATE: \_\_\_\_\_

ADDRESS: \_\_\_\_\_

PHONE: \_\_\_\_\_ FAX: \_\_\_\_\_



**health**

Department:  
Health  
PROVINCE OF KWAZULU-NATAL

**DIRECTORATE:**

Physical Address 800 Bellair road, Durban ,4001  
Postal Address Private bag X18, Mayville ,4058  
Tel: 031 240 2866 Fax 031 240 2880 Email: tommy.terblanche@kznhealth.gov.za  
www.kznhealth.gov.za

Regional Laundry Cato Manor

**DATE: 12/11/2021**

**Specification: RLCM**

SPECIFICATION FOR: TORCH PORTABLE RECHARGEABLE



NO.	SPECIFICATION	BIDDERS COMMENTS: STATE "COMPLIES" OR "DOES NOT COMPLY"	
Clause 1	The flashlight has a clip-on bracket that easily clips onto a belt, etc.		
Clause 2	The flashlight has a zoom function.		
Clause 3	Built-in battery with reverse protection function.		
Clause 4	1-meter impact resistance.		
Clause 5	Waterproof design.		
Clause 6	Material: Aluminum alloy.		
Clause 7	USB Chargeable.		

BIDDER: \_\_\_\_\_

SIGNATURE: \_\_\_\_\_ DATE: \_\_\_\_\_

ADDRESS: \_\_\_\_\_

PHONE: \_\_\_\_\_ FAX: \_\_\_\_\_



**health**

Department:  
Health  
PROVINCE OF KWAZULU-NATAL

**DIRECTORATE:**

Physical Address 800 Bellair road, Durban ,4001  
Postal Address Private bag X18, Mayville ,4058  
Tel: 031 240 2866 Fax 031 240 2980 Email: tommy.terblanche@kznhealth.gov.za  
www.kznhealth.gov.za

Regional Laundry Cato Manor

**DATE: 12/11/2021**

**Specification: RLCM**

SPECIFICATION FOR: WHEELBARROW



NO.	SPECIFICATION	BIDDERS COMMENTS: STATE "COMPLIES" OR "DOES NOT COMPLY"	
<b>Clause 1</b>	Heavy Duty SABS FG81049 Description Concrete Heavy Duty.		
<b>Clause 2</b>	Black Frame Pan gauge 1.2mm Pan rim 5.5mm steel reinforced.		
<b>Clause 3</b>	Wheel heavy duty rubber tyre. SABS wheel bearing $\text{Æ}25\text{mm}$ sintered.		
<b>Clause 4</b>	Pan capacity 65 Litre.		

BIDDER: \_\_\_\_\_

SIGNATURE: \_\_\_\_\_ DATE: \_\_\_\_\_

ADDRESS: \_\_\_\_\_

PHONE: \_\_\_\_\_ FAX: \_\_\_\_\_





**health**

Department:  
Health  
PROVINCE OF KWAZULU-NATAL

Physical Address 800 Bellair road, Durban ,4001  
Postal Address Private bag X18, Mayville ,4058  
Tel: 031 240 2866 Fax 031 240 2880 Email: tommy.terblanche@kznhealth.gov.za  
www.kznhealth.gov.za

**DIRECTORATE:**

Regional Laundry Cato Manor

**DATE: 12/11/2021**

**Specification: RLCM**

**SPECIFICATION FOR: ELECTRICAL SOCKET ELB TESTER**



NO.	SPECIFICATION	BIDDERS COMMENTS: STATE "COMPLIES" OR "DOES NOT COMPLY"	
Clause 1	Fixed current settings 10mA to 35Ma.		
Clause 2	Neon indication of wiring status.		
Clause 3	AC voltage indication on LCD display.		
Clause 4	Double injection rubberized overmould casing.		
Clause 5	Separate test button.		
Clause 6	Operating voltage 230V AC.		
Clause 7	Separate power cord ensures access to all plugs regardless of location.		
Clause 8	eparate momentary switch for ELCB avoids unnecessary tripping while testing polarity.		
Clause 9	P40 protection.		
Clause10	CAT III 600V.		