

SharePoint

Dube Nelisiwe

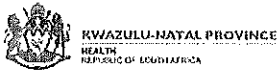

KZN HEALTH

KZN Health Intranet

- HOME
- CORPORATE INFORMATION
- COMPONENTS
- DIRECTORY
- DISTRICT OFFICES
- HEALTH FACILITIES

KZN Health > Components > Supply Chain Management

AdvertQuote

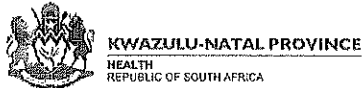

Quotation Advert

Opening Date: 2021-03-05

Closing Date: 2021-03-12

Closing Time: 11:00

INSTITUTION DETAILS

Institution Name: Othobothini CHC

Province: KwaZulu-Natal

Department or Entity: Department of Health

Division or section: Central Supply Chain Management

Place where goods / services is required: Othobothini CHC, D850 Road next to Msiyane High School, Jozini 3

Date Submitted: 2021-03-04

ITEM CATEGORY AND DETAILS

Quotation Number: ZNQ: OTH/288/21

Item Category: Goods

Item Description: SUPPLY AN DELIVER:FRAME OPTICAL DISPLAY RODS (3)
-VUSUAL ACUITY CHART PROJECTOR,LCD (1)
-AUTO REFRACTOR KERATOMER (1)

Quantity (If supplies)

COMPULSORY BRIEFING SESSION / SITE VISIT

Select Type: Not Applicable

Date :

Time:

Venue:

QUOTES CAN BE COLLECTED FROM: SCM OFFICE/DOWNLOAD FROM DEPARTMENT OF HEALTH WEBSITE

QUOTES SHOULD BE DELIVERED TO: OTHOBOTHINI CHC BY SECURITY MAIN
GATE/othobothini.quotations@gmail.com

ENQUIRIES REGARDING THE ADVERT MAY BE DIRECTED TO:

Name: MISS L.P MYENI

Email: othobothini.quotations@gmail.com

Contact Number: 082 938 4495

Finance Manager Name: MR B.L BUTHELEZI

Finance Manager Signature:

No late quotes will be considered

DECLARATION OF INTEREST

1. Any legal person, including persons employed by the state¹, or persons having a kinship with persons employed by the state, including a blood relationship, may make an offer or offers in terms of this invitation to quote (includes a price quotation, advertised competitive quote, limited quote or proposal). In view of possible allegations of favouritism, should the resulting quote, or part thereof, be awarded to persons employed by the state, or to persons connected with or related to them, it is required that the bidder or his/her authorised representative declare his/her position in relation to the evaluating/adjudicating authority where-
 - the bidder is employed by the state; and/or
 - the legal person on whose behalf the bidding document is signed, has a relationship with persons/a person who are/is involved in the evaluation and or adjudication of the quote(s), or where it is known that such a relationship exists between the person or persons for or on whose behalf the declarant acts and persons who are involved with the evaluation and or adjudication of the quote.
2. In order to give effect to the above, the following questionnaire must be completed and submitted with the quote.

- | | |
|--|---|
| 2.1. Full Name of bidder/representative..... | 2.4. Company Registration Number: |
| 2.2. Identity Number: | 2.5. Tax Reference Number: |
| 2.3. Position occupied in the Company (director, trustee, shareholder ²):..... | 2.6. VAT Registration Number: |

- 2.7. The names of all directors / trustees / shareholders / members, their individual identity numbers, tax reference numbers and, if applicable, employee / persal numbers must be indicated in paragraph 3 below. [TICK APPLICABLE]
- 2.8. Are you or any person connected with the bidder presently employed by the state? YES NO
- 2.8.1. If so, furnish the following particulars:
 - Name of person / director / trustee / shareholder/ member:
 - Name of state institution at which you or the person connected to the bidder is employed:.....
 - Position occupied in the state institution: Any other particulars:.....
- 2.8.2. If you are presently employed by the state, did you obtain the appropriate authority to undertake remunerative work outside employment in the public sector? YES NO
- 2.8.2.1. If yes, did you attach proof of such authority to the quote document? YES NO

(Note: Failure to submit proof of such authority, where applicable, may result in the disqualification of the quote.)

- 2.8.2.2. If no, furnish reasons for non-submission of such proof:
- 2.9. Did you or your spouse, or any of the company's directors / trustees / shareholders / members or their spouses conduct business with the state in the previous twelve months? YES NO
- 2.9.1. If so, furnish particulars:.....
- 2.10. Do you, or any person connected with the bidder, have any relationship (family, friend, other) with a person employed by the state and who may be involved with the evaluation and or adjudication of this quote? YES NO
- 2.10.1. If so, furnish particulars:.....
- 2.11. Are you, or any person connected with the bidder, aware of any relationship (family, friend, other) between any other bidder and any person employed by the state who may be involved with the evaluation and or adjudication of this quote? YES NO
- 2.11.1. If so, furnish particulars:.....
- 2.12. Do you or any of the directors / trustees / shareholders / members of the company have any interest in any other related companies whether or not they are bidding for this contract? YES NO
- 2.12.1. If so, furnish particulars:.....

3. Full details of directors / trustees / members / shareholders.

NB: The Department Of Health will validate details of directors / trustees / members / shareholders on CSD. It is the suppliers' responsibility to ensure that their details are up-to-date and verified on CSD. If the Department cannot validate the information on CSD, the quote will not be considered and passed over as non-compliant according to National Treasury Instruction Note 4 (a) 2016/17.

4 DECLARATION

I, THE UNDERSIGNED (NAME).....CERTIFY THAT THE INFORMATION FURNISHED IN PARAGRAPHS 2.

I ACCEPT THAT THE STATE MAY REJECT THE QUOTE OR ACT AGAINST ME SHOULD THIS DECLARATION PROVE TO BE FALSE.

..... Name of bidder Signature Position Date
-------------------------	--------------------	-------------------	---------------

¹"State" means –

- | | |
|---|---|
| a) any national or provincial department, national or provincial public entity or constitutional institution within the meaning of the Public Finance Management Act, 1999 (Act No. 1 of 1999); | c) provincial legislature; |
| b) any municipality or municipal entity; | d) national Assembly or the national Council of provinces; or |
| | e) Parliament. |

²"Shareholder" means a person who owns shares in the company and is actively involved in the management of the enterprise or business and exercises control over the enterprise.

SPECIAL CONTRACT CONDITIONS OF QUOTATIONS

1. AMENDMENT OF CONTRACT

- 1.1. Any amendment to or renunciation of the provisions of the contract shall at all times be done in writing and shall be signed by both parties.

2. CHANGE OF ADDRESS

- 2.1. Bidders must advise the Department of Health (institution where the offer was submitted) should their address (*domicilium citandi et executandi*) details change from the time of bidding to the expiry of the contract.

3. GENERAL CONDITIONS ATTACHED TO THIS QUOTATION

- 3.1. The institution is under no obligation to accept the lowest or any quote.
- 3.2. The price quoted must include VAT (if VAT vendor). However, it must be noted that the department reserves the right to evaluate all quotations excluding VAT as some bidders may not be VAT vendors.
- 3.3. The bidder must ensure the correctness & validity of quote:
- (i) *that the price(s), rate(s) & preference quoted cover all for the work/item (s) & accept that any mistakes regarding the price (s) & calculations will be at the bidder's risk*
- 3.4. The bidder must accept full responsibility for the proper execution & fulfilment of all obligations conditions devolving on under this agreement, as the Principal (s) liable for the due fulfilment of this contract.
- 3.5. This quotation will be evaluated based on the 80/20 points system, specification & correctness of information. All required documentation must be completed in full and submitted.
- 3.6. Offers must comply strictly with the specification.
- 3.7. Only offers that meet or are greater than the specification will be considered.
- 3.8. Late quotes will not be considered.
- 3.9. Expired product/s will not be accepted. All products supplied must be valid for a minimum period of six months.
- 3.10. A bidder not registered on the Central Suppliers Database or verification has failed will not be considered.
- 3.11. All delivery costs must be included in the quote price, for delivery at the prescribed destination.
- 3.12. Only firm prices will be accepted. Such prices must remain firm for the contract period. Non-firm prices (including rates of exchange variations) will not be considered.
- 3.13. In cases where different delivery points influence the pricing, a separate pricing schedule must be submitted for each delivery point.
- 3.14. In the event of a bidder having multiple quotes, only the cheapest according to specification will be considered. Furthermore a verification will be done to identify if bidders have multiple companies and are quoting (cover-quoting) for this bid. In such instances only the cheapest bid according to specification will be considered.

4. SPECIAL INSTRUCTIONS AND NOTICES TO BIDDERS REGARDING THE COMPLETION OF THIS QUOTATION.

- 4.1. Unless inconsistent with or expressly indicated otherwise by the context, the singular shall include the plural and vice versa and with words importing the masculine gender shall include the feminine and the neuter.
- 4.2. Under no circumstances whatsoever may the quotation/bid forms be retyped or redrafted. Photocopies of the original bid documentation may be used, but an original signature must appear on such photocopies.
- 4.3. The bidder is advised to check the number of pages and to satisfy himself that none are missing or duplicated.
- 4.4. Quotation submitted must be complete in all respects.
- 4.5. Any alteration made by the bidder must be initialled.
- 4.6. Use of correcting fluid is prohibited.
- 4.7. Quotation will be opened in public as soon as practicable after the closing time of quotation.
- 4.8. Where practical, prices are made public at the time of opening quotations.
- 4.9. If it is desired to make more than one offer against any individual item, such offers should be given on a photocopy of the page in question. Clear indication thereof must be stated on the schedules attached.

5. SPECIAL INSTRUCTIONS REGARDING HAND DELIVERED QUOTATIONS

- 5.1. Quotation shall be lodged at the address indicated not later than the closing time specified for their receipt, and in accordance with the directives in the quotation documents.
- 5.2. Each quotation shall be addressed in accordance with the directives in the quotation documents and shall be lodged in a separate sealed envelope, with the name and address of the bidder, the quotation number and closing date indicated on the envelope. The envelope shall not contain documents relating to any quotation other than that shown on the envelope. If this provision is not complied with, such quotations/bids may be rejected as being invalid.
- 5.3. All quotations received in sealed envelopes with the relevant quotation numbers on the envelopes are kept unopened in safe custody until the closing time of the quotation/bids. Where, however, a quotation is received open, it shall be sealed. If it is received without a quotation/bid number on the envelope, it shall be opened, the quotation number ascertained, the envelope sealed and the quotation number written on the envelope.
- 5.4. A specific box is provided for the receipt of quotations, and no quotation found in any other box or elsewhere subsequent to the closing date and time of quotation will be considered.

- 5.5. No quotation/bid sent through the post will be considered if it is received after the closing date and time stipulated in the quotation documentation, and proof of posting will not be accepted as proof of delivery.
- 5.6. Quotation documents must not be included in packages containing samples. Such quotations may be rejected as being invalid.

6. SAMPLES

- 6.1. In the case of the quote document stipulating that samples are required, the supplier will be informed in due course when samples should be provided to the institution. (This decreases the time of safety and storage risk that may be incurred by the respective institution). The bidders sample will be retained if such bidder wins the contract.
 - (i) If a company/s who has not won the quote requires their samples, they must advise the institution in writing of such.
 - (ii) If samples are not collected within three months of close of quote the institution reserves the right to dispose of them at their discretion.
- 6.2. **Samples must be made available when requested in writing or if stipulated on the document.**
 - (i) If a Bidder fails to provide a sample of their product on offer for scrutiny against the set specification when requested, their offer will be rejected. All testing will be for the account of the bidder.

7. COMPULSORY SITE INSPECTION / BRIEFING SESSION

7.1. Bidders who fail to attend the compulsory meeting will be disqualified from the evaluation process.

- (i) The institution has determined that a compulsory site meeting take place
- (ii) Date ____/____/____ Time ____:____ Place _____

Institution Stamp:	Institution Site Inspection / briefing session Official Full Name: Signature: Date:
--------------------	--

8. STATEMENT OF SUPPLIES AND SERVICES

8.1. The contractor shall, when requested to do so, furnish particulars of supplies delivered or services executed. If he/she fails to do so, the Department may, without prejudice to any other rights which it may have, institute inquiries at the expense of the contractor to obtain the required particulars.

9. SUBMISSION AND COMPLETION OF SBD 6.1

9.1. Should a bidder wish to qualify for preference points they must complete a SBD 6.1 document. Failure by a bidder to provide all relevant information required, will result in such a bidder not being considered for preference point's allocation. The preferences applicable on the closing date will be utilized. Any changes after the closing date will not be considered for that particular quote.

10. TAX COMPLIANCE REQUIREMENTS

- 10.1. In the event that the tax compliance status has failed on CSD, **it is the suppliers' responsibility to provide a SARS pin in order for the institution to validate the tax compliance status of the supplier.**
- 10.2. In the event that the institution cannot validate the suppliers' tax clearance on SARS as well as the Central Suppliers Database, **the quote will not be considered and passed over as non-compliant according to National Treasury Instruction Note 4 (a) 2016/17.**

11. TAX INVOICE

11.1. A tax invoice shall be in the currency of the Republic of South Africa and shall contain the following particulars:

- (i) the name, address and registration number of the supplier;
- (ii) the name and address of the recipient;
- (iii) an individual serialized number and the date upon which the tax invoice is issued;
- (iv) a description and quantity or volume of the goods or services supplied;
- (v) the official department order number issued to the supplier;
- (vi) the value of the supply, the amount of tax charged;
- (vii) the words tax invoice in a prominent place.

12. PATENT RIGHTS

The supplier shall indemnify the **KZN Department of Health** (here after known as the purchaser) against all third-party claims of infringement of patent, trademark, or industrial design rights arising from use of the goods or any part thereof by the purchaser.

13. PENALTIES

- 13.1. If at any time during the contract period, the service provider is unable to perform in a timely manner, the service provider must notify the institution in writing/email of the cause of and the duration of the delay. Upon receipt of the notification, the institution should evaluate the circumstances and, if deemed necessary, the institution may extend the service provider's time for performance.
- 13.2. In the event of delayed performance that extends beyond the delivery period, the institution is entitled to purchase commodities of a similar quantity and quality as a substitution for the outstanding commodities, without terminating the contract, as well as return commodities delivered at a later stage at the service provider's expense.
- 13.3. Alternatively, the institution may elect to terminate the contract and procure the necessary commodities in order to complete the contract. In the event that the contract is terminated the institution may claim damages from the service provider in the form of a penalty. The service provider's performance should be captured on the service provider database in order to determine whether or not the service provider should be awarded any contracts in the future.
- 13.4. If the supplier fails to deliver any or all of the goods or to perform the services within the period(s) specified in the contract, the purchaser shall, without prejudice to its other remedies under the contract, deduct from the contract price, as a penalty, a sum calculated on the delivered price of the delayed goods or unperformed services using the current prime interest rate calculated for each day of the delay until actual delivery or performance.

14. TERMINATION FOR DEFAULT

- 14.1. The purchaser, without prejudice to any other remedy for breach of contract, by written notice of default sent to the supplier, may terminate this contract in whole or in part:
 - (i) if the supplier fails to deliver any or all of the goods within the period(s) specified in the contract,
 - (ii) if the supplier fails to perform any other obligation(s) under the contract; or
 - (iii) if the supplier, in the judgment of the purchaser, has engaged in corrupt or fraudulent practices in competing for or in executing the contract.
- 14.2. In the event the purchaser terminates the contract in whole or in part, the purchaser may procure, upon such terms and in such manner as it deems appropriate, goods, works or services similar to those undelivered, and the supplier shall be liable to the purchaser for any excess costs for such similar goods, works or services.
- 14.3. Where the purchaser terminates the contract in whole or in part, the purchaser may decide to impose a restriction penalty on the supplier by prohibiting such supplier from doing business with the public sector for a period not exceeding 10 years.

15. FAILURE TO COMPLY WITH ABOVE WILL RESULT IN YOUR QUOTE BEING PASSED OVER.

PREFERENCE POINTS CLAIM FORM IN TERMS OF THE PREFERENTIAL PROCUREMENT REGULATIONS 2017

This preference form must form part of all quotes invited. It contains general information and serves as a claim form for preference points for Broad-Based Black Economic Empowerment (B-BBEE) Status Level of Contribution

NB: BEFORE COMPLETING THIS FORM, BIDDERS MUST STUDY THE GENERAL CONDITIONS, DEFINITIONS AND DIRECTIVES APPLICABLE IN RESPECT OF B-BBEE, AS PRESCRIBED IN THE PREFERENTIAL PROCUREMENT REGULATIONS, 2017.

1. GENERAL CONDITIONS

1.1 The following preference point systems are applicable to all quotes:

- the 80/20 system for requirements with a Rand value of up to R50 000 000 (all applicable taxes included); and

1.2 The value of this quote is estimated to not exceed R50 000 000 (all applicable taxes included) and therefore the 80/20 preference point system shall be applicable.

1.3 Points for this quote shall be awarded for:

- (a) Price; and
- (b) B-BBEE Status Level of Contributor.

1.4 The maximum points for this quote is allocated as follows:

	POINTS
PRICE	80
B-BBEE STATUS LEVEL OF CONTRIBUTOR	20
Total points for Price and B-BBEE must not exceed	100

1.5 Failure on the part of a bidder to submit proof of B-BBEE Status level of contributor together with the quote, will be interpreted to mean that preference points for B-BBEE status level of contribution are not claimed.

1.6 The purchaser reserves the right to require of a bidder, either before a quote is adjudicated or at any time subsequently, to substantiate any claim in regard to preferences, in any manner required by the purchaser.

2. DEFINITIONS

- (a) **"B-BBEE"** means broad-based black economic empowerment as defined in section 1 of the Broad-Based Black Economic Empowerment Act;
- (b) **"B-BBEE status level of contributor"** means the B-BBEE status of an entity in terms of a code of good practice on black economic empowerment, issued in terms of section 9(1) of the Broad-Based Black Economic Empowerment Act;
- (c) **"bid"** means a written offer in a prescribed or stipulated form in response to an invitation by an organ of state for the provision of goods or services, through price quotations, advertised competitive bidding processes or proposals;
- (d) **"Broad-Based Black Economic Empowerment Act"** means the Broad-Based Black Economic Empowerment Act, 2003 (Act No. 53 of 2003);
- (e) **"EME"** means an Exempted Micro Enterprise in terms of a code of good practice on black economic empowerment issued in terms of section 9 (1) of the Broad-Based Black Economic Empowerment Act;
- (f) **"functionality"** means the ability of a tenderer to provide goods or services in accordance with specifications as set out in the tender documents.
- (g) **"prices"** includes all applicable taxes less all unconditional discounts;
- (h) **"proof of B-BBEE status level of contributor"** means:
 - 1) B-BBEE Status level certificate issued by an authorized body or person;
 - 2) A sworn affidavit as prescribed by the B-BBEE Codes of Good Practice;
 - 3) Any other requirement prescribed in terms of the B-BBEE Act;
- (i) **"QSE"** means a qualifying small business enterprise in terms of a code of good practice on black economic empowerment issued in terms of section 9 (1) of the Broad-Based Black Economic Empowerment Act;
- (j) **"rand value"** means the total estimated value of a contract in Rand, calculated at the time of bid invitation, and includes all applicable taxes;

3. POINTS AWARDED FOR PRICE

3.1 THE 80/20 PREFERENCE POINT SYSTEMS

A maximum of 80 points is allocated for price on the following basis:

$$P_s = 80 \left(1 - \frac{P_t - P_{\min}}{P_{\min}} \right) \text{ Where}$$

- Ps = Points scored for price of bid under consideration
- Pt = Price of bid under consideration
- Pmin = Price of lowest acceptable bid

4. POINTS AWARDED FOR B-BBEE STATUS LEVEL OF CONTRIBUTOR

4.1 In terms of Regulation 6 (2) and 7 (2) of the Preferential Procurement Regulations, preference points must be awarded to a bidder for attaining the B-BBEE status level of contribution in accordance with the table below:

B-BBEE Status Level of Contributor	Number of points (80/20 system)
1	20
2	18
3	14
4	12
5	8
6	6
7	4
8	2
Non-compliant contributor	0

5. BID DECLARATION

5.1 Bidders who claim points in respect of B-BBEE Status Level of Contribution must complete the following:

6. B-BBEE STATUS LEVEL OF CONTRIBUTOR CLAIMED IN TERMS OF PARAGRAPHS 1.4 AND 4.1

6.1 B-BBEE Status Level of Contributor: =(maximum of 20 points)

(Points claimed in respect of paragraph 7.1 must be in accordance with the table reflected in paragraph 4.1 and must be substantiated by relevant proof of B-BBEE status level of contributor.

7. SUB-CONTRACTING

(Tick applicable box)

7.1 Will any portion of the contract be sub-contracted?

YES	<input type="checkbox"/>	NO	<input type="checkbox"/>
-----	--------------------------	----	--------------------------

7.1.1 If yes, indicate:

- i) What percentage of the contract will be subcontracted.....%
- ii) The name of the sub-contractor.....
- iii) The B-BBEE status level of the sub-contractor.....

8. Whether the sub-contractor is an EME or QSE

(Tick applicable box)

iv) Specify, by ticking the appropriate box, if subcontracting with an enterprise in terms of Preferential Procurement Regulations, 2017:

YES	<input type="checkbox"/>	NO	<input type="checkbox"/>
-----	--------------------------	----	--------------------------

Designated Group: An EME or QSE which is at least 51% owned by:	EME √	QSE √
Black people		
Black people who are youth		
Black people who are women		
Black people with disabilities		
Black people living in rural or underdeveloped areas or townships		
Cooperative owned by black people		
Black people who are military veterans		
OR		
Any EME		
Any QSE		

9. **DECLARATION WITH REGARD TO COMPANY/FIRM**

9.1 Name of company/firm:.....

9.2 VAT registration number:.....

9.3 Company registration number:.....

9.4 **TYPE OF COMPANY/ FIRM [TICK APPLICABLE BOX]**

- Partnership/Joint Venture / Consortium
- One person business/sole propriety
- Close corporation
- Company
- (Pty) Limited

9.5 **DESCRIBE PRINCIPAL BUSINESS ACTIVITIES**

.....
.....

9.6 **COMPANY CLASSIFICATION [TICK APPLICABLE BOX]**

- Manufacturer
- Supplier
- Professional service provider
- Other service providers, e.g. transporter, etc.

9.7 Total number of years the company/firm has been in business:.....

9.8 I/we, the undersigned, who is / are duly authorised to do so on behalf of the company/firm, certify that the points claimed, based on the B-BBE status level of contributor indicated in paragraphs 1.4 and 6.1 of the foregoing certificate, qualifies the company/ firm for the preference(s) shown and I / we acknowledge that:

- i) The information furnished is true and correct;
- ii) The preference points claimed are in accordance with the General Conditions as indicated in paragraph 1 of this form;
- iii) In the event of a contract being awarded as a result of points claimed as shown in paragraphs 1.4 and 6.1, the contractor may be required to furnish documentary proof to the satisfaction of the purchaser that the claims are correct;
- iv) If the B-BBEE status level of contributor has been claimed or obtained on a fraudulent basis or any of the conditions of contract have not been fulfilled, the purchaser may, in addition to any other remedy it may have –
 - (a) disqualify the person from the bidding process;
 - (b) recover costs, losses or damages it has incurred or suffered as a result of that person's conduct;
 - (c) cancel the contract and claim any damages which it has suffered as a result of having to make less favourable arrangements due to such cancellation;
 - (d) recommend that the bidder or contractor, its shareholders and directors, or only the shareholders and directors who acted on a fraudulent basis, be restricted by the National Treasury from obtaining business from any organ of state for a period not exceeding 10 years, after the *audi alteram partem* (hear the other side) rule has been applied; and
 - (e) forward the matter for criminal prosecution.

<p>WITNESSES</p> <p>1.</p> <p>2.</p>
--

<p>.....</p> <p>SIGNATURE(S) OF BIDDERS(S)</p> <p>DATE:</p> <p>ADDRESS.....</p> <p>.....</p> <p>.....</p>

ZNQ:



health

Department:
Health
PROVINCE OF KWAZULU-NATAL

Physical Address: D850 Road (Next to Msiyane High school) Jozini, 3969
Postal Address: P/Bag X12, Jozini, 3969
Tel: 035 5917004 Fax: 035 572 1245
Email: jozini.chc@gmail.com

DIRECTORATE: SUPPLY CHAIN MANAGEMENT

OTHOBOTHINI CHC

**ITEM: VISUAL ACUITY CHART PROJECTOR LCD, AUTO REFRACTOR KERATOMETER & FRAME OPTICAL DISPLAY RODS
SPECIFICATION DOCUMENT**

Item #	DESCRIPTION	Bidder's Comment: Offer will Comply?		Remarks
		Yes	NO	
1.	<p><u>Visual acuity chart projector LCD</u></p> <ul style="list-style-type: none"> -Size: +/- 45x4cm -Colour: clear/transparent / white plastic / steel -Material: clear/white hard plastic -Package: Unit -Functionality/performance: optotypes randomisation, reversible test -Purpose: for different assessment charts projection over 100 charts projection -with Snellen charts, landolt c's, illiterate's, numbers of symbols, contrast charts, low vision chart, binocular charts, red/green (duochrome) filters - Standard accessory: IR Remote-controller, Wall-mount bracket <p>(Picture attached)</p>	<input checked="" type="checkbox"/>	<input type="checkbox"/>	

Company (Bidder's) Name: Representative (Signature):

<p>2.</p>	<p><u>Auto refractor keratometer</u> -Size: 275mmx525mmx450mm, +/-18kg -Colour: White/Grey/Black -Functionality/performance: motorized 65mm chinrest, mvmt -Purpose: object refraction + corneal curvate measurement - Spherical degree: 25D to +22D in 0.25 steps - Cylinder degree: 0.00 D to + 10.00 D (step :0.25D) - Axis: 1° to 180 (step 1°) -Vertex distance: 0.00,10,12,13.5mm of 15mm - Minimum pupil diameter: 2.0mm - Radius of curvature: 6.5 mm to 94 mm (step : 0.02mm) - Printer: Thermal printer - Display: 6.4 inch TFT display (Picture attached)</p>			
<p>3.</p>	<p><u>Frame optical display rods</u> -Wall mounted eyewear display rack bars lockable -Size: 12-16 slots -Material: stainless steel -Colour: white -For eyewear display -Style: Hanging - Type: L stand (Picture attached)</p>			

ZNQ:

The guarantee period must not be less than 24 Months from delivery date			
The item must be according to SABS standard and /approved			

Note:

- The Bidder is requested to state whether the offer comply or not comply (tick "yes" or "No") with above specification.
- The Bidder must fully compete and sign this specification document.

NB: Failure to comply with the above instructions will invalidate the Quote

VISUAL ACUITY CHART PROJECTOR LCD

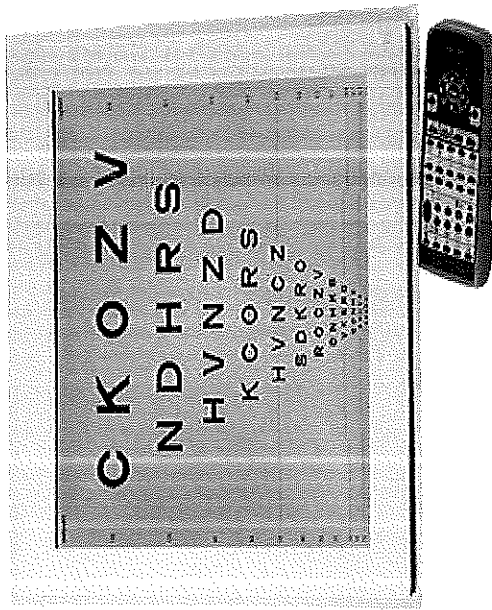

Company (Bidder's) Name: Representative (Signature):

ZNQ:

AUTO REFRACTOR KERATOMETER

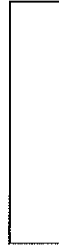
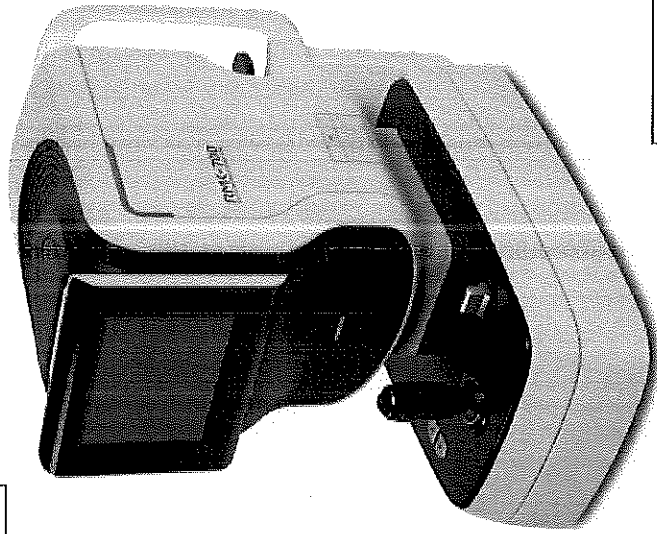
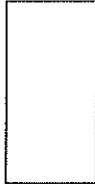

Company (Bidder's) Name: Representative (Signature):

ZNQ:

FRAME OPTICAL DISPLAY RODS LOCKABLE

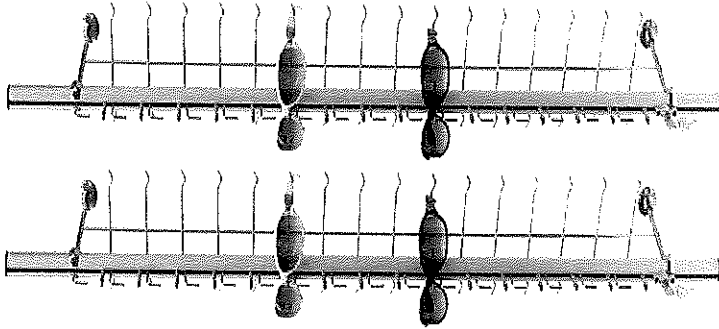

with lock
16 x 1 = 16ft

Company (Bidder's) Name: Representative (Signature):