

SharePoint

Nxumalo Lindelwa ▾ ?



KZN HEALTH

KZN Health Intranet

Search this site



HOME CORPORATE INFORMATION COMPONENTS DIRECTORY DISTRICT OFFICES HEALTH FACILITIES

KZN Health > Components > Supply Chain Management

AdvertQuote



Quotation Advert

Opening Date: 2021-11-16

Closing Date: 2021-11-29

Closing Time: 11:00

INSTITUTION DETAILS

Institution Name: East Boom CHC

Province: KwaZulu-Natal

Department or Entity: Department of Health

Division or section: Central Supply Chain Management

Place where goods / services is required: Northdale clinic

Date Submitted: 2021-11-16

ITEM CATEGORY AND DETAILS

Quotation Number: ZNQ:
ESB 256/22

Item Category: Services

Item Description: TO INSTALL 10 000 LITRE WATER STORAGE TANK AT NORTHDALE CLINIC.
SEE SPECIFICATION ATTACHED

Quantity (if supplies): 01 UNIT

COMPULSORY BRIEFING SESSION / SITE VISIT

Select Type: Compulsory Briefing Session

Date: 2021-11-19

Time: 11H00

Venue: EAST BOOM CHC (PATIENTS WAITING AREA SHELTER) BOOM STREET SIDE

QUOTES CAN BE COLLECTED FROM: QUOTATION DOCUMENTS ATTACHED WITH ADVERT (PLEASE PRINT)

QUOTES SHOULD BE DELIVERED TO: 541 BOOM STREET, Pietermaritzburg OR EMAIL:
Quotations.EastBoom@kznhealth.gov.za

ENQUIRIES REGARDING THE ADVERT MAY BE DIRECTED TO:

Name: Ms L.Nxumalo

Email:

Contact Number: 033 264 4936

Finance Manager Name:

MR J.D KHUMALO

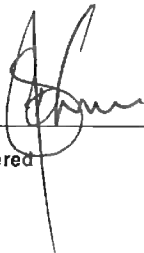

Finance Manager Signature:

No late quotes will be considered

DECLARATION OF INTEREST

1. Any legal person, including persons employed by the state¹, or persons having a kinship with persons employed by the state, including a blood relationship, may make an offer or offers in terms of this invitation to quote (includes a price quotation, advertised competitive quote, limited quote or proposal). In view of possible allegations of favouritism, should the resulting quote, or part thereof, be awarded to persons employed by the state or to persons connected with or related to them, it is required that the bidder or his/her authorised representative declare his/her position in relation to the evaluating/adjudicating authority where-
 - the bidder is employed by the state; and/or
 - the legal person on whose behalf the bidding document is signed, has a relationship with persons/a person who are/is involved in the evaluation and or adjudication of the quote(s), or where it is known that such a relationship exists between the person or persons for or on whose behalf the declarant acts and persons who are involved with the evaluation and or adjudication of the quote.
2. In order to give effect to the above, the following questionnaire must be completed and submitted with the quote.

- 2.1. Full Name of bidder/representative.....
- 2.2. Identity Number:
- 2.3. Position occupied in the Company (director, trustee, shareholder²):
- 2.4. Company Registration Number:
- 2.5. Tax Reference Number:
- 2.6. VAT Registration Number:

2.7. The names of all directors / trustees / shareholders / members, their individual identity numbers, tax reference numbers and, if applicable, employee / persal numbers must be indicated in paragraph 3 below. [TICK APPLICABLE]

2.8. Are you or any person connected with the bidder presently employed by the state? YES NO

2.8.1. If so, furnish the following particulars:
 Name of person / director / trustee / shareholder/ member:
 Name of state institution at which you or the person connected to the bidder is employed:.....
 Position occupied in the state institution:Any other particulars:.....

2.8.2. If you are presently employed by the state, did you obtain the appropriate authority to undertake remunerative work outside employment in the public sector? YES NO

2.8.2.1. If yes, did you attach proof of such authority to the quote document?

(Note: Failure to submit proof of such authority, where applicable, may result in the disqualification of the quote.)

2.8.2.2. If no, furnish reasons for non-submission of such proof:

2.9. Did you or your spouse, or any of the company's directors / trustees / shareholders / members or their spouses conduct business with the state in the previous twelve months? YES NO

2.9.1. If so, furnish particulars:.....

2.10. Do you, or any person connected with the bidder, have any relationship (family, friend, other) with a person employed by the state and who may be involved with the evaluation and or adjudication of this quote? YES NO

2.10.1. If so, furnish particulars:.....

2.11. Are you, or any person connected with the bidder, aware of any relationship (family, friend, other) between any other bidder and any person employed by the state who may be involved with the evaluation and or adjudication of this quote? YES NO

2.11.1. If so, furnish particulars:.....

2.12. Do you or any of the directors / trustees / shareholders / members of the company have any interest in any other related companies whether or not they are bidding for this contract? YES NO

2.12.1. If so, furnish particulars:.....

3. Full details of directors / trustees / members / shareholders.

NB: The Department Of Health will validate **details of directors / trustees / members / shareholders** on CSD. It is the suppliers' responsibility to ensure that their details are up-to-date and verified on CSD. If the Department cannot validate the **information** on CSD, the quote will not be considered and passed over as non-compliant according to National Treasury Instruction Note 4 (a) 2016/17.

4 DECLARATION

I, THE UNDERSIGNED (NAME).....CERTIFY THAT THE INFORMATION FURNISHED IN PARAGRAPHS 2.

I ACCEPT THAT THE STATE MAY REJECT THE QUOTE OR ACT AGAINST ME SHOULD THIS DECLARATION PROVE TO BE FALSE.

..... Name of bidder Signature Position Date
-------------------------	--------------------	-------------------	---------------

¹"State" means –

- | | |
|---|---|
| a) any national or provincial department, national or provincial public entity or constitutional institution within the meaning of the Public Finance Management Act, 1999 (Act No. 1 of 1999); | c) provincial legislature; |
| b) any municipality or municipal entity; | d) national Assembly or the national Council of provinces; or |
| | e) Parliament. |

²"Shareholder" means a person who owns shares in the company and is actively involved in the management of the enterprise or business and exercises control over the enterprise.

SPECIAL CONTRACT CONDITIONS OF QUOTATIONS

1. AMENDMENT OF CONTRACT

- 1.1. Any amendment to or renunciation of the provisions of the contract shall at all times be done in writing and shall be signed by both parties.

2. CHANGE OF ADDRESS

- 2.1. Bidders must advise the Department of Health (institution where the offer was submitted) should their address (*domicilium citandi et executandi*) details change from the time of bidding to the expiry of the contract.

3. GENERAL CONDITIONS ATTACHED TO THIS QUOTATION

- 3.1. The Department is under no obligation to accept the lowest or any quote.
- 3.2. The Department reserves the right to communicate in writing with vendors in cases where information is incomplete or where there are obscurities regarding technical aspects of the offer, to obtain confirmation of prices or preference claims in cases where it is evident that a typing, written, transfer or unit error has been made, to investigate the vendor's standing and ability to complete the supply/service satisfactorily.
- 3.3. **ALL DECISIONS TAKEN BY THE DEPARTMENT ARE FINAL, INCLUDING THE AWARD OF THIS QUOTATION.**
- 3.4. The price quoted must include VAT (if VAT vendor). However, it must be noted that the Department reserves the right to evaluate all quotations excluding VAT as some bidders may not be VAT vendors.
- 3.5. The bidder must ensure the correctness & validity of the quotation:
- (i) *that the price(s), rate(s) & preference quoted cover all for the work/item (s) & accept that any mistakes regarding the price (s) & calculations will be at the bidder's risk*
 - (ii) *it is the responsibility of the bidder to confirm receipt of their quotation and to keep proof thereof.*
- 3.6. The bidder must accept full responsibility for the proper execution & fulfilment of all obligations conditions devolving on under this agreement, as the Principal (s) liable for the due fulfilment of this contract.
- 3.7. This quotation will be evaluated based on the 80/20 points system, specification, correctness of information and/or functionality criteria. All required documentation must be completed in full and submitted.
- 3.8. Offers must comply strictly with the specification.
- 3.9. Only offers that meet or are greater than the specification will be considered.
- 3.10. Late offers will not be considered.
- 3.11. Expired product/s will not be accepted. All products supplied must be valid for a minimum period of six months.
- 3.12. Used/ second-hand products will not be accepted.
- 3.13. A bidder not registered on the Central Suppliers Database or whose verification has failed will not be considered.
- 3.14. All delivery costs must be included in the quoted price for delivery at the prescribed destination.
- 3.15. Only firm prices will be accepted. Such prices must remain firm for the contract period. Non-firm prices (including rates of exchange variations) will not be considered.
- 3.16. In cases where different delivery points influence the pricing, a separate pricing schedule must be submitted for each delivery point.
- 3.17. In the event of a bidder having multiple quotes, only the cheapest according to specification will be considered.
- 3.18. Verification will be conducted to identify if bidders have multiple companies and are cover-quoting for this bid.
- 3.19. In such instances, the Department reserves the right to immediately disqualify such bidders as cover-quoting is an offence that represents both corruption and acquisition fraud.

4. SPECIAL INSTRUCTIONS AND NOTICES TO BIDDERS REGARDING THE COMPLETION OF THIS QUOTATION.

- 4.1. Unless inconsistent with or expressly indicated otherwise by the context, the singular shall include the plural and vice versa and with words importing the masculine gender shall include the feminine and the neuter.
- 4.2. Under no circumstances whatsoever may the quotation/bid forms be retyped or redrafted. Photocopies of the original bid documentation may be used, but an original signature must appear on such photocopies.
- 4.3. The bidder is advised to check the number of pages and to satisfy himself that none are missing or duplicated.
- 4.4. Quotations submitted must be complete in all respects. However, where it is identified that information in a bidder's response is incomplete in any respect, the said supplier meets all specification requirements and is lowest to quote, the Department reserves the right to request the bidder to complete/submit such information.
- 4.5. Any alteration made by the bidder must be initialled; failure to do so may render the response invalid.
- 4.6. Use of correcting fluid is prohibited and may render the response invalid.
- 4.7. Quotations will be opened in public as soon as practicable after the closing time of quotation.
- 4.8. Where practical, prices are made public at the time of opening quotations.
- 4.9. If it is desired to make more than one offer against any individual item, such offers should be given on a photocopy of the page in question. Clear indication thereof must be stated on the schedules attached.
- 4.10. The Department is under no obligation to pay suppliers in part for work done if the supplier can no longer for fulfil their obligation.

5. SPECIAL INSTRUCTIONS REGARDING HAND DELIVERED QUOTATIONS

- 5.1. Quotation shall be lodged at the address indicated not later than the closing time specified for their receipt, and in accordance with the directives in the quotation documents.
- 5.2. Each quotation shall be addressed in accordance with the directives in the quotation documents and shall be lodged in a separate sealed envelope, with the name and address of the bidder, the quotation number and closing date indicated on the envelope. The envelope shall not contain documents relating to any quotation other than that shown on the envelope. If this provision is not complied with, such quotations/bids may be rejected as being invalid.
- 5.3. All quotations received in sealed envelopes with the relevant quotation numbers on the envelopes are kept unopened in safe custody until the closing time of the quotation/bids. Where, however, a quotation is received open, it shall be sealed. If it is received without a quotation/bid number on the envelope, it shall be opened, the quotation number ascertained, the envelope sealed and the quotation number written on the envelope.
- 5.4. A specific box is provided for the receipt of quotations, and no quotation found in any other box or elsewhere subsequent to the closing date and time of quotation will be considered.
- 5.5. No quotation/bid sent through the post will be considered if it is received after the closing date and time stipulated in the quotation documentation, and proof of posting will not be accepted as proof of delivery.
- 5.6. Quotation documents must not be included in packages containing samples. Such quotations may be rejected as being invalid.

6. SAMPLES

- 6.1. In the case of the quote document stipulating that samples are required, the supplier will be informed in due course when samples should be provided to the institution. (This decreases the time of safety and storage risk that may be incurred by the respective institution). The bidders sample will be retained if such bidder wins the contract.
 - (i) If a company/s who has not won the quote requires their samples, they must advise the institution in writing of such.
 - (ii) If samples are not collected within three months of close of quote the institution reserves the right to dispose of them at their discretion.
- 6.2. **Samples must be made available when requested in writing or if stipulated on the document.**
 - (i) If a Bidder fails to provide a sample of their product on offer for scrutiny against the set specification when requested, their offer will be rejected. All testing will be for the account of the bidder.

7. COMPULSORY SITE INSPECTION / BRIEFING SESSION

7.1. Bidders who fail to attend the compulsory meeting will be disqualified from the evaluation process.

- (i) The institution has determined that a compulsory site meeting take place
- (ii) Date Time : Place

Institution Stamp:	Institution Site Inspection / briefing session Official Full Name: Signature: Date:
--------------------	--

8. STATEMENT OF SUPPLIES AND SERVICES

8.1. The contractor shall, when requested to do so, furnish particulars of supplies delivered or services executed. If he/she fails to do so, the Department may, without prejudice to any other rights which it may have, institute inquiries at the expense of the contractor to obtain the required particulars.

9. SUBMISSION AND COMPLETION OF SBD 6.1

9.1. Should a bidder wish to qualify for preference points they must complete a SBD 6.1 document. Failure by a bidder to provide all relevant information required, will result in such a bidder not being considered for preference point's allocation. The preferences applicable on the closing date will be utilized. Any changes after the closing date will not be considered for that particular quote.

10. TAX COMPLIANCE REQUIREMENTS

- 10.1. In the event that the tax compliance status has failed on CSD, **it is the suppliers' responsibility to provide a SARS pin in order for the institution to validate the tax compliance status of the supplier.**
- 10.2. In the event that the institution cannot validate the suppliers' tax clearance on SARS as well as the Central Suppliers Database, **the quote will not be considered and passed over as non-compliant according to National Treasury Instruction Note 4 (a) 2016/17.**

11. TAX INVOICE

11.1. A tax invoice shall be in the currency of the Republic of South Africa and shall contain the following particulars:

- | | |
|--|--|
| (i) the name, address and registration number of the supplier; | (iv) a description and quantity or volume of the goods or services supplied; |
| (ii) the name and address of the recipient; | (v) the official department order number issued to the supplier; |
| (iii) an individual serialized number and the date upon which the tax invoice is issued; | (vi) the value of the supply, the amount of tax charged; |
| | (vii) the words tax invoice in a prominent place. |

12. PATENT RIGHTS

The supplier shall indemnify the **KZN Department of Health** (hereafter known as the purchaser) against all third-party claims of infringement of patent, trademark, or industrial design rights arising from use of the goods or any part thereof by the purchaser.

13. PENALTIES

- 13.1. If at any time during the contract period, the service provider is unable to perform in a timely manner, the service provider must notify the institution in writing/email of the cause of and the duration of the delay. Upon receipt of the notification, the institution should evaluate the circumstances and, if deemed necessary, the institution may extend the service provider's time for performance.
- 13.2. In the event of delayed performance that extends beyond the delivery period, the institution is entitled to purchase commodities of a similar quantity and quality as a substitution for the outstanding commodities, without terminating the contract, as well as return commodities delivered at a later stage at the service provider's expense.
- 13.3. Alternatively, the institution may elect to terminate the contract and procure the necessary commodities in order to complete the contract. In the event that the contract is terminated the institution may claim damages from the service provider in the form of a penalty. The service provider's performance should be captured on the service provider database in order to determine whether or not the service provider should be awarded any contracts in the future.
- 13.4. If the supplier fails to deliver any or all of the goods or to perform the services within the period(s) specified in the contract, the purchaser shall, without prejudice to its other remedies under the contract, deduct from the contract price, as a penalty, a sum calculated on the delivered price of the delayed goods or unperformed services using the current prime interest rate calculated for each day of the delay until actual delivery or performance.

14. TERMINATION FOR DEFAULT

- 14.1. The purchaser, without prejudice to any other remedy for breach of contract, by written notice of default sent to the supplier, may terminate this contract in whole or in part:
- (i) if the supplier fails to deliver any or all of the goods within the period(s) specified in the contract,
 - (ii) if the supplier fails to perform any other obligation(s) under the contract; or
 - (iii) if the supplier, in the judgment of the purchaser, has engaged in corrupt or fraudulent practices in competing for or in executing the contract.
- 14.2. In the event the purchaser terminates the contract in whole or in part, the purchaser may procure, upon such terms and in such manner as it deems appropriate, goods, works or services similar to those undelivered, and the supplier shall be liable to the purchaser for any excess costs for such similar goods, works or services.
- 14.3. Where the purchaser terminates the contract in whole or in part, the purchaser may decide to impose a restriction penalty on the supplier by prohibiting such supplier from doing business with the public sector for a period not exceeding 10 years.

15. FAILURE TO COMPLY WITH ABOVE WILL RESULT IN YOUR QUOTE BEING PASSED OVER.

PREFERENCE POINTS CLAIM FORM IN TERMS OF THE PREFERENTIAL PROCUREMENT REGULATIONS 2017

This preference form must form part of all quotes invited. It contains general information and serves as a claim form for preference points for Broad-Based Black Economic Empowerment (B-BBEE) Status Level of Contribution

NB: BEFORE COMPLETING THIS FORM, BIDDERS MUST STUDY THE GENERAL CONDITIONS, DEFINITIONS AND DIRECTIVES APPLICABLE IN RESPECT OF B-BBEE, AS PRESCRIBED IN THE PREFERENTIAL PROCUREMENT REGULATIONS, 2017.

1. GENERAL CONDITIONS

- 1.1 The following preference point systems are applicable to all quotes:
- the 80/20 system for requirements with a Rand value of up to R50 000 000 (all applicable taxes included); and
- 1.2 The value of this quote is estimated to not exceed R50 000 000 (all applicable taxes included) and therefore the 80/20 preference point system shall be applicable.
- 1.3 Points for this quote shall be awarded for:
- (a) Price; and
 - (b) B-BBEE Status Level of Contributor.
- 1.4 The maximum points for this quote is allocated as follows:

	POINTS
PRICE	80
B-BBEE STATUS LEVEL OF CONTRIBUTOR	20
Total points for Price and B-BBEE must not exceed	100

- 1.5 Failure on the part of a bidder to submit proof of B-BBEE Status level of contributor together with the quote, will be interpreted to mean that preference points for B-BBEE status level of contribution are not claimed.
- 1.6 The purchaser reserves the right to require of a bidder, either before a quote is adjudicated or at any time subsequently, to substantiate any claim in regard to preferences, in any manner required by the purchaser.

2. DEFINITIONS

- (a) **"B-BBEE"** means broad-based black economic empowerment as defined in section 1 of the Broad-Based Black Economic Empowerment Act;
- (b) **"B-BBEE status level of contributor"** means the B-BBEE status of an entity in terms of a code of good practice on black economic empowerment, issued in terms of section 9(1) of the Broad-Based Black Economic Empowerment Act;
- (c) **"bid"** means a written offer in a prescribed or stipulated form in response to an invitation by an organ of state for the provision of goods or services, through price quotations, advertised competitive bidding processes or proposals;
- (d) **"Broad-Based Black Economic Empowerment Act"** means the Broad-Based Black Economic Empowerment Act, 2003 (Act No. 53 of 2003);
- (e) **"EME"** means an Exempted Micro Enterprise in terms of a code of good practice on black economic empowerment issued in terms of section 9 (1) of the Broad-Based Black Economic Empowerment Act;
- (f) **"functionality"** means the ability of a tenderer to provide goods or services in accordance with specifications as set out in the tender documents.
- (g) **"prices"** includes all applicable taxes less all unconditional discounts;
- (h) **"proof of B-BBEE status level of contributor"** means:
 - 1) B-BBEE Status level certificate issued by an authorized body or person;
 - 2) A sworn affidavit as prescribed by the B-BBEE Codes of Good Practice;
 - 3) Any other requirement prescribed in terms of the B-BBEE Act;
- (i) **"QSE"** means a qualifying small business enterprise in terms of a code of good practice on black economic empowerment issued in terms of section 9 (1) of the Broad-Based Black Economic Empowerment Act;
- (j) **"rand value"** means the total estimated value of a contract in Rand, calculated at the time of bid invitation, and includes all applicable taxes;

3. POINTS AWARDED FOR PRICE

3.1 THE 80/20 PREFERENCE POINT SYSTEMS

A maximum of 80 points is allocated for price on the following basis:

$$P_s = 80 \left(1 - \frac{P_t - P_{\min}}{P_{\min}} \right) \text{ Where}$$

- P_s = Points scored for price of bid under consideration
- P_t = Price of bid under consideration
- P_{min} = price of lowest acceptable bid

4. POINTS AWARDED FOR B-BBEE STATUS LEVEL OF CONTRIBUTOR

4.1 In terms of Regulation 6 (2) and 7 (2) of the Preferential Procurement Regulations, preference points must be awarded to a bidder for attaining the B-BBEE status level of contribution in accordance with the table below:

B-BBEE Status Level of Contributor	Number of points (80/20 system)
1	20
2	18
3	14
4	12
5	8
6	6
7	4
8	2
Non-compliant contributor	0

5. BID DECLARATION

5.1 Bidders who claim points in respect of B-BBEE Status Level of Contribution must complete the following:

6. B-BBEE STATUS LEVEL OF CONTRIBUTOR CLAIMED IN TERMS OF PARAGRAPHS 1.4 AND 4.1

6.1 B-BBEE Status Level of Contributor: =(maximum of 20 points)

(Points claimed in respect of paragraph 7.1 must be in accordance with the table reflected in paragraph 4.1 and must be substantiated by relevant proof of B-BBEE status level of contributor.)

7. SUB-CONTRACTING applicable box)

(Tick

YES	NO
-----	----

7.1 Will any portion of the contract be sub-contracted?

7.1.1 If yes, indicate:

- i) What percentage of the contract will be subcontracted.....%
- ii) The name of the sub-contractor.....
- iii) The B-BBEE status level of the sub-contractor.....

8. Whether the sub-contractor is an EME or QSE

(Tick applicable box)

iv) Specify, by ticking the appropriate box, if subcontracting with an enterprise in terms of Preferential Procurement Regulations, 2017:

YES	NO
-----	----

Designated Group: An EME or QSE which is at least 51% owned by:	EME	QSE
Black people	√	√
Black people who are youth		
Black people who are women		
Black people with disabilities		
Black people living in rural or underdeveloped areas or townships		
Cooperative owned by black people		
Black people who are military veterans		
OR		
Any EME		

9. DECLARATION WITH REGARD TO COMPANY/FIRM

9.1 Name of company/firm:.....

9.2 VAT registration number:.....

9.3 Company registration number:.....

9.4 TYPE OF COMPANY/ FIRM [TICK APPLICABLE BOX]

- Partnership/Joint Venture / Consortium
- One person business/sole propriety
- Close corporation
- Company
- (Pty) Limited

9.5 DESCRIBE PRINCIPAL BUSINESS ACTIVITIES

.....

9.6 COMPANY CLASSIFICATION [TICK APPLICABLE BOX]

- Manufacturer
- Supplier
- Professional service provider
- Other service providers, e.g. transporter, etc.

9.7 Total number of years the company/firm has been in business:.....

9.8 I/we, the undersigned, who is / are duly authorised to do so on behalf of the company/firm, certify that the points claimed, based on the B-BBE status level of contributor indicated in paragraphs 1.4 and 6.1 of the foregoing certificate, qualifies the company/ firm for the preference(s) shown and I / we acknowledge that:

- i) The information furnished is true and correct;
- ii) The preference points claimed are in accordance with the General Conditions as indicated in paragraph 1 of this form;
- iii) In the event of a contract being awarded as a result of points claimed as shown in paragraphs 1.4 and 6.1, the contractor may be required to furnish documentary proof to the satisfaction of the purchaser that the claims are correct;
- iv) If the B-BBEE status level of contributor has been claimed or obtained on a fraudulent basis or any of the conditions of contract have not been fulfilled, the purchaser may, in addition to any other remedy it may have –
 - (a) disqualify the person from the bidding process;
 - (b) recover costs, losses or damages it has incurred or suffered as a result of that person's conduct;
 - (c) cancel the contract and claim any damages which it has suffered as a result of having to make less favourable arrangements due to such cancellation;
 - (d) recommend that the bidder or contractor, its shareholders and directors, or only the shareholders and directors who acted on a fraudulent basis, be restricted by the National Treasury from obtaining business from any organ of state for a period not exceeding 10 years, after the *audi alteram partem* (hear the other side) rule has been applied; and
 - (e) forward the matter for criminal prosecution.

<p>WITNESSES</p> <p>1.</p> <p>2.</p>

<p>.....</p> <p>SIGNATURE(S) OF BIDDERS(S)</p> <p>DATE:</p> <p>ADDRESS.....</p> <p>.....</p> <p>.....</p>
--

Quote Number: ZNQ

Item Description: Installation and commissioning of 10KL water storage tank x 1

Department/Section: Northdale Clinic

Purpose of Item: INFRASTRUCTURE MAINTENANCE

1. Pre-qualification criteria if any:

1.1. Is the item required to have a regulatory body certification (e.g. SABS, SANS, SANAS, ISO, CIDB, etc.)? Yes / No:

Regulatory Body / certification required if Yes:

- A COPY OF A VALID AND ACTIVE MINIMUM CIDB GRADE: 1CE MUST BE ATTACHED TO THE BID.
- A LIST OF MINIMUM THREE (3) TRACEABLE REFERENCES WHERE SIMILAR PROJECTS WERE CONDUCTED OR COMPLETED MUST BE ATTACHED WITH THE BID.
- COPIES OF CV'S OF THE PROJECT TEAM MEMBERS INCLUDING CERTIFIED COPIES OF QUALIFICATIONS MUST BE ATTACHED TO THE BID.

1.2. Is a compulsory site inspection / briefing session required? Yes / No

1.3. Is local production and content part of the quote? Yes / No

if Yes, specify: 100%

1.4. Provisions of section 4(1)(a) of the PPPFA Regulations, 2017 if applicable? Yes / No

if Yes, specify: _____

1.5. Liability Cover insurance? Yes / No

if Yes, specify:

- A VALID DEPARTMENT OF LABOUR LETTER OF GOODSTANDING MUST BE ATTACHED TO THE BID.
- THE SUCCESSFUL BIDDING COMPANY SHALL BE REQUIRED TO PRESENT COPIES OF A VALID AND ACTIVE LIABILITY COVER INSURANCE POLICY SCHEDULE ON SITE HANDOVER.

NB: FAILURE TO ADHERE TO THE ABOVE REQUIREMENTS SHALL RESULT IN THE DISQUALIFICATION OF THE BID.

JOINT VENTURES ARE ELIGIBLE TO SUBMIT TENDERS PROVIDED THAT:

- a) EVERY MEMBER OF THE JOINT VENTURE IS REGISTERED WITH THE CIDB.
- b) THE LEAD PARTNER HAS A CONTRACTOR GRADING DESIGNATION IN THE 1CE CLASS OF CONSTRUCTION WORKS
- c) A VALID JOINT VENTURE AGREEMENT MUST BE ATTACHED TO THE BID.

2. What is the specification of the required item?

**PROVINCE OF KWAZULU-NATAL
DEPARTMENT OF HEALTH**

INSTALLATION AND COMMISSIONING OF 1 X 10 000L WATER STORAGE TANK AT NORTHDAL CLINIC

ZNQ

1. PROJECT SPECIFICATIONS

1.1 SCOPE OF CONTRACT

This Contract is for the execution of the project indicated above.

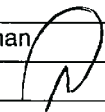
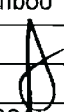
Name of End-user (in full)	Mr T Mkhize	Name of SCM Rep (in full)	Mr A Simboo
Designation / Rank (in full)	Artisan Foreman	Designation/ Rank (in full)	SMO
Signature		Signature	
Date	10/11/2021	Date	10/11/2021

1.2 CONTRACT DRAWINGS

Drawing N/A

1.3 CONDITIONS OF CONTRACT AND PRELIMINARIES

1.3.1 PERIOD OF CONTRACT

Eight (8) Weeks as the Contract Period for the completion of the Work from date of Site handover.

1.3.2 CONTRACT GUARANTEE:

N/A

1.3.3 GUARANTEE PERIOD

Twenty four months (Two Years) workmanship and structural galvanised steel longevity up to 40 years

1.3.3.1 PENALTY FOR NON COMPLETION

Penalties of 7% of the contract value a day shall apply from specified completion date.

1.3.4 SITE AND MODE OF PROCEDURE

The Contractor/Bidder is advised that the existing premises will be occupied throughout the period of the contract, all security measures in force will remain in operation and that the minimum amount of disruption to services is of the utmost importance. The contractor will on no account extend his operation beyond the confines of the building site as indicated and must ensure that all his employees are made aware of these limits. Any employee disregarding this instruction and found outside the limit of the building site without authority, shall be redeployed immediately and shall not again be employed on this contract.

The Contractor will be responsible for ensuring that this instruction is strictly enforced and must provide and remove upon completion or when directed, such other necessary temporary barriers, fences, etc. as may be required and is to allow opposite this item for any charges he may wish to make in this connection.

The Employer will accept no responsibility whatsoever for damage to or loss of buildings, plant, materials, etc. from the site.

The installation must be to the satisfaction of the Kwa Zulu- Natal Department of Health. Bidders are advised to visit the site prior to tendering and to acquaint themselves with the nature of the work to be done and access to the siting of the existing buildings etc., as no claim whatsoever will be allowed on the grounds of ignorance of the conditions under which the work will be executed.

1.3.5 SATISFACTORY INSTALLATION

The whole installation shall be carried out in accordance with the South African Bureau of Standards Code of Practice for the application of National Building Regulations, applicable SANS 1921 standards, and the health department standard Preambles to all Trades.

Copies of the health department Standard Preambles to all Trades are available at the office of the Secretary for Health – KwaZulu-Natal and can be obtained on request.

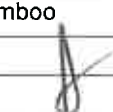
Name of End-user (in full)	Mr T Mkhize	Name of SCM Rep (in full)	Mr A Simboo
Designation / Rank (in full)	Artisan Foreman	Designation/ Rank (in full)	SMO
Signature		Signature	
Date	10/11/2021	Date	10/11/2021

1.3.6 PROOF OF COMPLIANCE WITH THE LAW:

The following certificates must be provided before first delivery is taken:

- Plumbing Compliance Certificate
- Lightning Compliance Certificate
- Soil Protection Certificate
- Concrete test and cube Certificate
- Waterproofing Guarantee Certificate
- Soil compaction Certificate
- Plumbing and drainage pressure test Certificates
- Latest National building Regulation
- Latest National building Regulation

1.3.7 GENERAL

The bidder /contractor will be responsible for all plumbing work associated with the standby water storage tank, structural work and concrete work and making good of all work. The trenching, patching and must be to the satisfaction of the KwaZulu-Natal Department of Health

2. TECHNICAL SPECIFICATION

GENERAL PROVISION APPLYING TO THE SYSTEM AND STANDARD SPECIFICATION

Although not bound in nor issued with this document, the latest issues of the following standards and specifications shall form part of this contract.

1. SANS 1921 Design structure
2. Hot Dipped Galvanised to SANS 121 ISO 1461
3. Occupational Health and Safety Act, 1993
4. NRB SANS 10400

All material must be SABS approved.

NB: Awarded contractor will have to work hand in hand with an OM of the Facility to arrange suitable time for water connection to a new storage tank.

2.1 GENERAL

This TECHNICAL SPECIFICATION shall be read in conjunction with all other sections of the SPECIFICATION and cognisance shall be taken of the clauses relevant to this particular installation, whether any specific clauses are referred to or not.

The bidder shall submit letter of good standing from Department of Labour
The bidder shall submit a minimum of three (3) references for previous similar projects
The bidder shall submit proof of CIDB Grade 1CE

2.1.1 SCOPE

Installation of the 10kl standby water storage tank at Northdale Clinic, leaving in service condition to the satisfaction of the Secretary and Project leader for Health KwaZulu-Natal.

2.1.2 WORK TO BE CARRIED OUT

Supply, install and commission elevated 10kl standby water storage tank at Northdale Clinic with an objective to provide storage of water for future usage in the event of emergency and drought. It will also improve working condition and ensure facility is safe and complies with the Occupational

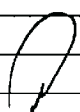
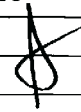
Name of End-user (in full)	Mr T Mkhize	Name of SCM Rep (in full)	Mr A Simbo
Designation / Rank (in full)	Artisan Foreman	Designation/ Rank (in full)	SMO
Signature		Signature	
Date	10/11/2021	Date	10/11/2021

Health and Safety regulations.

Overviews of the works:

- Constructions of elevated water tank foundation.
- Installation of elevated water tank
- Commissioning of elevated water tank
- The bidder shall compile and present a full detailed project plan which shall include milestones on the execution of the project within the contract period prior to commencement of works.

Location of the works:

- Northdale Clinic, 67 Bangalore Road, Northdale, Pietermaritzburg. Co-ordinates: – 29.5705822, 30.4008392.

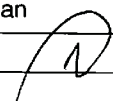
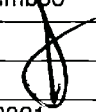
Name of End-user (in full)	Mr T Mkhize	Name of SCM Rep (in full)	Mr A Simboo
Designation / Rank (in full)	Artisan Foreman	Designation/ Rank (in full)	SMO
Signature		Signature	
Date	10/11/2021	Date	10/11/2021

**PROVINCE OF KWAZULU-NATAL
DEPARTMENT OF HEALTH**

ZNQ

3. SCHEDULE OF RATES

PREAMBLE TO SCHEDULE OF RATES

Items and Pricing

The Department reserves the right to place an order for any quantities of items included in the Schedules. The Schedule of Rates must also not be assumed to include and describe every detail of the supply requirement, but must be taken and read in conjunction with the other parts of the document. Thus the supplier shall not have claim for further payment in respect of any order, which may be described or implied in the contract, although apparently no corresponding items are given in the Schedule of Rates. The supplier shall be deemed to have satisfied himself before tendering as to the correctness and sufficiency of his tender for the contract and of the rates and prices stated in the Schedule of Rates.

Tax and Duties

Prices, tendered and paid, must include all customs, excise and import duties, and any other tariffs or taxes levied by the government or statutory body having jurisdiction on the goods provided under this contract, **including Value Added Tax (applicable to the current rate).**

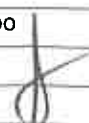

Rates

Except where provision is made in the Schedule of Rates, the rates and prices inserted shall be the full rates and prices for the service delivered described under the respective items and shall cover all labour, transport, overhead charges and profit, etc. as well as the general liabilities, obligations and risks arising out of the Conditions of Contract, the overhead charges and profit being spread proportionately over the rates of the relative items in the Schedule of Rates.

Name of End-user (in full)	Mr T Mkhize	Name of SCM Rep (in full)	Mr A Simboo
Designation / Rank (in full)	Artisan Foreman	Designation/ Rank (in full)	SMO
Signature		Signature	
Date	10/11/2021	Date	10/11/2021

WORK TO BE DONE AND SCHEDULE OF RATES:

Item	DESCRIPTION: INSTALLATION AND COMMISSIONING OF 1 X 10 000L WATER STORAGE TANK AT NORTHDAL CLINIC	UNIT	QTY	RATE/ UNIT		TOTAL	
				R	c	R	c
	<p>NOTE:</p> <p>1) All rates for items contained in this Schedule of Prices must be computed excluding the applicable Sales Tax.</p> <p>2) All rates quoted shall be inclusive of transport, labour and profit.</p> <p>3) The contractor must liaise with the local councillor and clinic committee for community to be involved with the installation of the park homes</p> <p>4) Site to be left in same condition as found</p> <p>5) Proper identification and PPE's when working on site/ signing visitors book</p>						
	<p>Geotechnical Test:</p> <p>Allow for a geotechnical specialist to test ground samples and produce a Geotech report for the site which will allow the professional structural civil design engineer to do foundation design.</p>	Item					
	<p>Site Clearance:</p> <p>Digging up and removing vegetation including compaction and carting away excavated material.</p>	No	01				
1)	Excavation for 3m x 3m x 0.5m base	m ³	4.6				
4)	Extra over trench and hole excavations in earth for excavation in soft rock.	m ³	0.5				
5)	200mm thick G5 material compacted to 98% MOD AASHTO density under base	m ³	1.4				
6)	<p>30mpa reinforced concrete cast against excavated surface</p> <p>800mm base complete with holding down bolts for the tower structure</p>	m ³	7.2				
7)	<p>Test cubes</p> <p>Making and testing 150 x 150 x 150mm concrete strength</p>	No	01				
8)	Steel reinforcement for the base as per design.	Ton	0.73				
9)	Formwork to sides of base including 50mm binding and 50mm grout.	m ²	09				
Carried To Collection Summary				PS 1	R		

Name of End-user (in full)	Mr T Mkhize	Name of SCM Rep (in full)	Mr A Simboo
Designation / Rank (in full)	Artisan Foreman	Designation/ Rank (in full)	SMO
Signature		Signature	
Date	10/11/2021	Date	10/11/2021

WORK TO BE DONE AND SCHEDULE OF RATES:

Item	UNIT	QTY	RATE/ UNIT		TOTAL		
			R	c	R	c	
10)	Supply, install and commission elevated 1830 x 1220 x 1220mm (10KL) domestic water storage tank (Complete with covers, ball float valve, pressure control valve, air release valve, scour valve, valve chamber, ball pressure valve, coupling, level indicator, overflow, inlet, outlet and 65 drain connection as scheduled and specified (Including a steel structure 10m high to support the tank complete with ladder, balustrade, bolt etc. Allow for a 65mm diameter bore for drain and overflow facility, 50mm diameter bore for water inlet facility and 75mm diameter for water outlet facility and earthing. As per manufacture details.	No	01				
11)	Supply and install galvanised (GSM) 75mm nominal bore (Tank water outlet pipe), c/w fittings and support with pipe markers and 1 x water meter. (Provisional quantity)	m	35				
12)	Plumbing and drainage: Excavation in earth not exceeding 1m depth for pipe trenches including backfilling to pipe trenches compacted and 100mm bedding under and filling around pipes.	m ³	24				
21)	Supply and lay 75mm uPVC class 9 including pressure. (Provisional quantity)	m	47				
22)	Supply and install one HA1 padlock c.w keys for cat ladder trap and water meter sleeve.	No	2				
23)	Re-surfacing of non-earth finishes (tar, concrete and road markings etc.)	m ²	1.4				
24)	Allow for a registered engineer to design all work pertaining to the tank stand foundation and slab, supplying of design certificate, engineering drawing, foundation construction specification and supervision of construction and certifying of foundation on site.	Item	1				
25)	Allow to supply Health and Safety file to project leader prior to commencement of project.	Item	1				
26)	Allow for EPWP appointments, compensation as per gazzeted rates including provision of the PPE	No	4				
Carried To Collection Summary			PS 2	R			

Name of End-user (in full)	Mr T Mkhize	Name of SCM Rep (in full)	Mr A Simboo
Designation / Rank (in full)	Artisan Foreman	Designation/ Rank (in full)	SMO
Signature		Signature	
Date	10/11/2021	Date	10/11/2021

CONSTRUCTION IN THIS DRAWING SHALL BE IN ACCORDANCE WITH THE SPECIFICATIONS FOR FOUNDATIONS AND EXCAVATION WORKS PREPARED BY THE CONTRACTOR.

GENERAL NOTES
 1. THIS DRAWING SHALL BE USED IN ACCORDANCE WITH THE FOUNDATION SPECIFICATIONS
 2. THIS DRAWING SHALL BE SOILED
 3. ANY DIMENSIONS NOT BE INDICATED SHALL BE CHECKED PRIOR TO CONSTRUCTION.
 4. SPECIAL INSTRUCTIONS
 5. ALL CONCRETE TO BE CAST 28days / 28days FOUNDATIONS 1 item

RELATIVE HUBS RELATIVE TO THE HUBS OF THE HUBS AS PER THE SURVEY INFORMATION

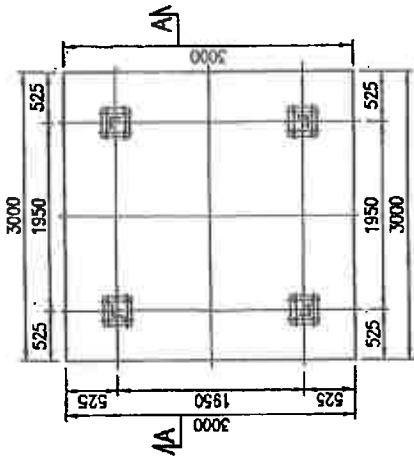

PLAN ON FOUNDATION
SCALE 1:50

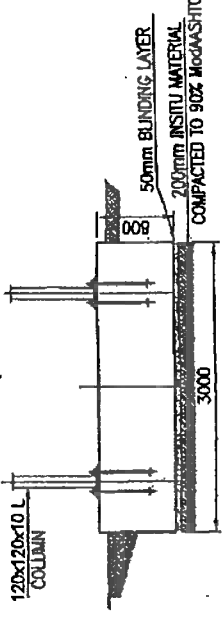

SECTION A-A
SCALE 1:50

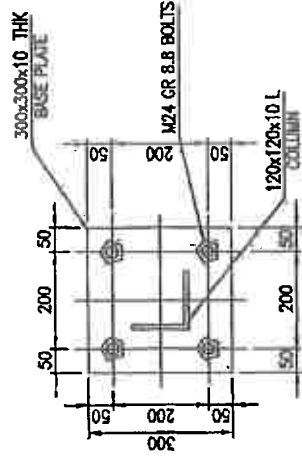

BASE PLATE PLAN
SCALE 1:10

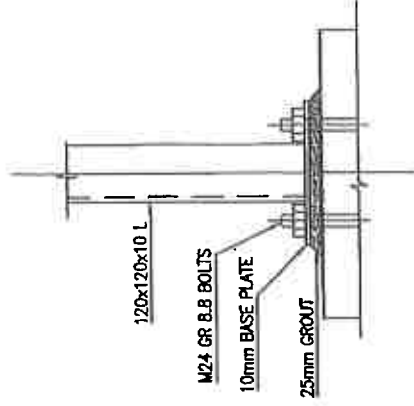

BASE PLATE SECTION
SCALE 1:10

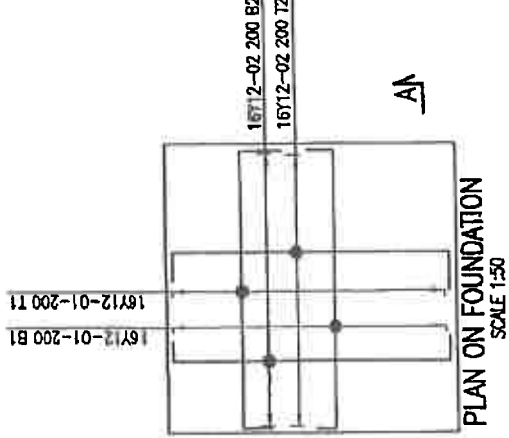

PLAN ON FOUNDATION
SCALE 1:50

Approved
 2/9/2024

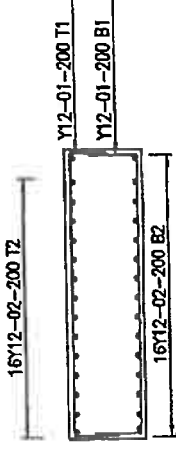

SECTION A-A
SCALE 1:50

EARTHWORKS NOTES

- 1. SITE TO BE CLEARED OF VEGETATION
- 2. 150mm TOP SOIL TO BE EXCAVATED TO SPILL
- 3. THE ENGINEER TO VERIFY SOIL CLASS BEFORE EXCAVATION OF FOUNDATIONS
- 4. SHOULD THE SOIL HAVE UNDESIRABLE CHARACTERISTICS, THE ENGINEER TO ADVISE ON REMEDY
- 5. INSITU MATERIAL TO BE COMPACTED TO 93% MODULUS RHO
- 6. NO WORKS TO BE COVERED BEFORE INSPECTION AND APPROVAL

MEMBER	No. OF MEMBER	TYPE	TOTAL No.	LENGTH	MARK	SHAPE CODE	BENDING							
							A	B	C	D	E/T			
FOOTING 1	32	Y12	32	3700	01	38	400	29000						
	32	Y12	32	3900	02	38	500	29000						
TOT														

8	10	12	15	20	25	32	40	TOT
R								
Y								
TOT								

DOMINANT SOIL CLASS IS S1

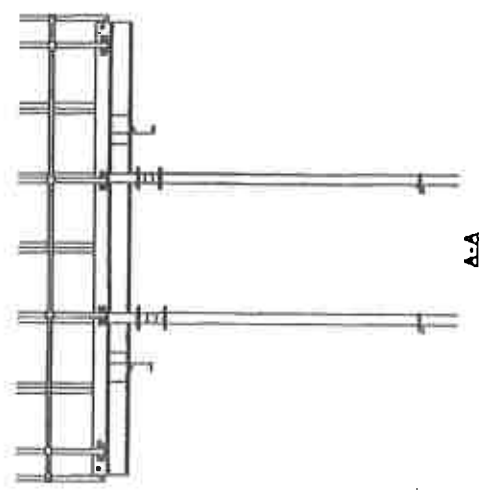
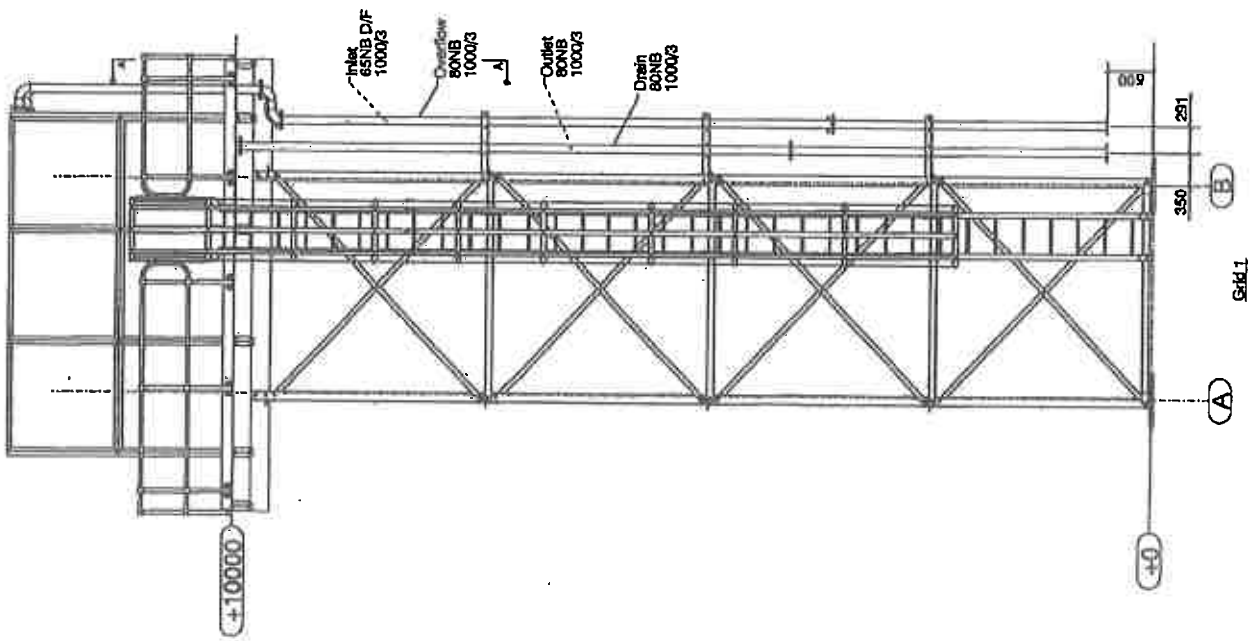

00 REC'D
 00 JAN 11

11 General Arrangement Drawing

0 2 11

180

COLLECTION SUMMARY

ZNQ

INSTALLATION AND COMMISSIONING OF 1 X 10 000L WATER STORAGE TANK AT NORTHDALÉ CLINIC

NOTE:

THIS COLLECTION SUMMARY MUST BE COMPLETED IN FULL BY THE CONTRACTOR AND RETURNED TOGETHER WITH THE TENDER FORM.

Collection Summary PS 1	R		
Collection Summary PS 2	R		
SUB-TOTAL "A"	R		
(Where Applicable) ADD Provision for Value Added Tax Allow 15% of SUB-TOTAL "A"	R		
TOTAL: CARRIED TO TENDER FORM	R		

Name of End-user (in full)	Mr T Mkhize	Name of SCM Rep (in full)	Mr A Simboo
Designation / Rank (in full)	Artisan Foreman	Designation/ Rank (in full)	SMO
Signature		Signature	
Date	10/11/2021	Date	10/11/2021



END-USER SPECIFICATION FORM

3. Does a sample need to be submitted? Yes / No(select option 3.1 or 3.2)

3.1. Deadline for submission if Yes: Date / / Time : Place

or

3.2. Specify that samples must be made available when requested in writing. Yes or No

4. Penalties to be noted by the suppliers:

4.1. If the supplier fails to deliver any or all of the goods or to perform the services within the period(s) specified in the contract, the purchaser shall, without prejudice to its other remedies under the contract, **deduct from the contract price**, as a penalty, a sum calculated on the delivered price of the delayed goods or unperformed services using the current prime interest rate calculated for each day of the delay until actual delivery or performance.

5. What is the evaluation criteria / special terms and conditions to be advertised?

List evaluation criteria / special terms and conditions to be advertised (if applicable)	
1. Pre-qualification criteria	Does the offer meet the pre-qualification criteria?
2. Administrative	Does the offer comply to stipulated administrative requirements?
3. Conformance:	Was the product made or service performed to specifications?
4. Performance:	Will/does the product/service fulfil its performance obligation, in a manner that releases the supplier from all liabilities under the contract?
5. Features:	What characteristics does the product or service have?
6. Reliability:	How long can a product go between failures and the need for maintenance? (guarantee)
7. Durability:	What is the useful life for the product? How will the product hold up under extended use?
8. Serviceability:	How easy is it to repair, maintain or support the product or service? (customer support)
9. Ability & Capacity	The ability and capacity of the vendor to execute the contract
10. Preference points	Preferential Procurement System (80/20) if applicable

Name of End-user (in full)	Mr T Mkhize	Name of SCM Rep (in full)	Mr A Simboo
Designation / Rank (in full)	Artisan Foreman	Designation/ Rank (in full)	SMO
Signature		Signature	
Date	10/11/2021	Date	10/11/2021

T2.5 JOINT VENTURES INVOLVEMENT DECLARATION

Project title:	UTHUKELA DISTRICT - INSTALLATION AND COMMISSIONING OF 16 x 20KL WATER STORAGE TANK INSTALLATION AND COMMISSIONING OF 10KL WATER STORAGE TANK		
Bid no:	ZNB10011/2021-H	Project Code:	N/A

DECLARATION RELATING TO A BID SUBMITTED BY A JOINT VENTURE :

I/We the undersigned parties do hereby declare that our respective involvement in the Works, of which I/we tender by Joint Venture, would be as follows :-

Party No. 1	
CENTRAL SUPPLIERS DATABASE REGISTRATION NO:	
BIDDERS CIDB REGISTRATION NUMBER:	
Name	
Address	
Percentage Involvement	%

Party No. 2	
CENTRAL SUPPLIERS DATABASE REGISTRATION NO:	
BIDDERS CIDB REGISTRATION NUMBER:	
Name	
Address	
Percentage Involvement	%

Party No. 3	
CENTRAL SUPPLIERS DATABASE REGISTRATION NO:	
BIDDERS CIDB REGISTRATION NUMBER:	
Name	
Address	
Percentage Involvement	%

42

Signed - Party No. 1

I/We (Full Name) _____

duly authorised in my capacity as _____

of (Enterprise name): _____

do jointly and severally accept responsibility for the due performance of the Works contained in the above project should such bid submitted by the Joint Venture be accepted.

Signed by Authorised Representative

Date

Signed - Party No. 2

I/We (Full Name) _____

duly authorised in my capacity as _____

of (Enterprise name): _____

do jointly and severally accept responsibility for the due performance of the Works contained in the above project should such tender submitted by the Joint Venture be accepted.

Signed by Authorised Representative

Date

Signed - Party No. 3

I/We (Full Name) _____

duly authorised in my capacity as _____

of (Enterprise name): _____

do jointly and severally accept responsibility for the due performance of the Works contained in the above project should such tender submitted by the Joint Venture be accepted.

Signed by Authorised Representative

Date

43

DECLARATION CERTIFICATE FOR LOCAL PRODUCTION AND CONTENT

This Standard Bidding Document (SBD) must form part of all bids invited. It contains general information and serves as a declaration form for local content (local production and local content are used interchangeably).

Before completing this declaration, bidders must study the General Conditions, Definitions, Directives applicable in respect of Local Content as prescribed in the Preferential Procurement Regulations, 2011 and the South African Bureau of Standards (SABS) approved technical specification number SATS 1286:201x.

1. General Conditions

- 1.1. Preferential Procurement Regulations, 2011 (Regulation 9. (1) and 9. (3) make provision for the promotion of local production and content.
- 1.2. Regulation 9.(1) prescribes that in the case of designated sectors, where in the award of bids local production and content is of critical importance, such bids must be advertised with the specific bidding condition that only locally produced goods, services or works or locally manufactured goods, with a stipulated minimum threshold for local production and content will be considered.
- 1.3. Regulation 9.(3) prescribes that where there is no designated sector, a specific bidding condition may be included, that only locally produced services, works or goods or locally manufactured goods with a stipulated minimum threshold for local production and content, will be considered.
- 1.4. Where necessary, for bids referred to in paragraphs 1.2 and 1.3 above, a two stage bidding process may be followed, where the first stage involves a minimum threshold for local production and content and the second stage price and B-BBEE.
- 1.5. A person awarded a contract in relation to a designated sector, may not sub-contract in such a manner that the local production and content of the overall value of the contract is reduced to below the stipulated minimum threshold.
- 1.6. The local content (LC) as a percentage of the bid price must be calculated in accordance with the SABS approved technical specification number SATS 1286: 201x as follows:

$$LC = 1 - \left[\frac{x}{y} \right] \times 100$$

Where

x imported content

y bid price excluding value added tax (VAT)

Prices referred to in the determination of x must be converted to Rand (ZAR) by using the exchange rate published by South African Reserve Bank (SARB) at 12:00 on the date, one week (7 calendar days) prior to the closing date of the bid as indicated in paragraph 4.1 below.

- 1.7. A bid will be disqualified if:

- the bidder fails to achieve the stipulated minimum threshold for local production and content indicated in paragraph 3 below; and.
- this declaration certificate is not submitted as part of the bid documentation.

2. Definitions

- 2.1. **"bid"** includes advertised competitive bids, written price quotations or proposals;
- 2.2. **"bid price"** price offered by the bidder, excluding value added tax (VAT);
- 2.3. **"contract"** means the agreement that results from the acceptance of a bid by an organ of state;
- 2.4. **"designated sector"** means a sector, sub-sector or industry that has been designated by the Department of Trade and Industry in line with national development and industrial policies for local production, where only locally produced services, works or goods or locally manufactured goods meet the stipulated minimum threshold for local production and content;
- 2.5. **"duly sign"** means a Declaration Certificate for Local Content that has been signed by the Chief Financial Officer or other legally responsible person nominated in writing by the Chief Executive, or senior member / person with management responsibility (close corporation, partnership or individual).
- 2.6. **"imported content"** means that portion of the bid price represented by the cost of components, parts or materials which have been or are still to be imported (whether by the supplier or its subcontractors) and which costs are inclusive of the costs abroad, plus freight and other direct importation costs, such as landing costs, dock duties, import duty, sales duty or other similar tax or duty at the South African port of entry;
- 2.7. **"local content"** means that portion of the bid price which is not included in the imported content, provided that local manufacture does take place;
- 2.8. **"stipulated minimum threshold"** means that portion of local production and content as determined by the Department of Trade and Industry; and
- 2.9. **"sub-contract"** means the primary contractor's assigning, leasing, making out work to, or employing another person to support such primary contractor in the execution of part of a project in terms of the contract.
3. The stipulated minimum threshold(s) for local production and content for this bid is/are as follows:

<u>Description of services, works or goods</u>	<u>Stipulated minimum threshold</u>
_____	_____ %
_____	_____ %
_____	_____ %

4. Does any portion of the services, works or goods offered have any imported content?

YES / NO

4.1 If yes, the rate(s) of exchange to be used in this bid to calculate the local content as prescribed in paragraph 1.6 of the general conditions must be the rate(s) published by SARB for the specific currency at 12:00 on the date, one week (7 calendar days) prior to the closing date of the bid.

The relevant rates of exchange information is accessible on www.reservebank.co.za.

Indicate the rate(s) of exchange against the appropriate currency in the table below:

Currency	Rates of exchange
US Dollar	
Pound Sterling	
Euro	
Yen	
Other	

NB: Bidders must submit proof of the SARB rate (s) of exchange used.

LOCAL CONTENT DECLARATION BY CHIEF FINANCIAL OFFICER OR OTHER LEGALLY RESPONSIBLE PERSON NOMINATED IN WRITING BY THE CHIEF EXECUTIVE OR SENIOR MEMBER/PERSON WITH MANAGEMENT RESPONSIBILITY (CLOSE CORPORATION, PARTNERSHIP OR INDIVIDUAL)

IN RESPECT OF BID No.

ISSUED BY: (Procurement Authority / Name of Institution):
.....

NB The obligation to complete, duly sign and submit this declaration cannot be transferred to an external authorized representative, auditor or any other third party acting on behalf of the bidder.

I, the undersigned, (full names), do hereby declare, in my capacity as of(name of bidder entity), the following:

(a) The facts contained herein are within my own personal knowledge.

(b) I have satisfied myself that the goods/services/works to be delivered in terms of the above-specified bid comply with the minimum local content requirements as specified in the bid, and as measured in terms of SATS 1286.

(c) The local content has been calculated using the formula given in clause 3 of SATS 1286, the rates of exchange indicated in paragraph 4.1 above and the following figures:

Bid price, excluding VAT (y)	R
Imported content (x)	R
Stipulated minimum threshold for Local content (paragraph 3 above)	
Local content % , as calculated in terms of SATS 1286	

Annex C

Local Content Declaration - Summary Schedule

- (C1) Tender No.
- (C2) Tender description:
- (C3) Designated product(s)
- (C4) Tender Authority:
- (C5) Tendering Entity name:
- (C6) Tender Exchange Rate:
- (C7) Specified local content %:

Pula EU GBP
 Note: VAT to be excluded from all calculations

Tender Item no's	List of Items	Calculation of local content						Tender Authority			
		Tender price - each (excl VAT)	Exempted Imported value	Tender value net of exempted imported content	Imported value	Local value	Local content % (per item)	Tender Qty	Total tender value	Total exempted imported content	Total Imported content
(C8)	(C9)	(C10)	(C11)	(C12)	(C13)	(C14)	(C15)	(C16)	(C17)	(C18)	(C19)

Signature of tenderer from Annex B _____
 Date: _____

(C20) Total tender value R 0
 (C21) Total Exempt Imported content R 0
 (C22) Total Tender value net of exempt imported content R 0
 (C23) Total Imported content R 0
 (C24) Total local content R 0
 (C25) Average local content % of tender

Annex D

SATS 1256_2011

Imported Content Declaration - Supporting Schedule to Annex C

(D1) Tender No. _____
 (D2) Tender description: _____
 (D3) Designated Products: _____
 (D4) Tender Authority: _____
 (D5) Tendering Entity name: _____
 (D6) Tender Exchange Rate: _____

Note: VAT to be included from all calculations

EU R 9.00 GBP R 12.00

A. Exempted imported content

Tender Item no's	Description of imported content	Local supplier	Overseas Supplier	Foreign currency value of per Commercial Invoice	Tender Exchange Rate	Calculation of Import Value			Summary		
						Local value of Imports	Freight costs to part of entry	All locally incurred landing costs & duties	Total landed cost and VAT	Tender City	Exempted imported value
(D7)	(D8)	(D9)	(D10)	(D11)	(D12)	(D13)	(D14)	(D15)	(D16)	(D17)	(D18)
										(D19) Total exempted imported value	R 0

B. Imported directly by the Tenderer

Tender Item no's	Description of imported content	Unit of measure	Overseas Supplier	Foreign currency value of per Commercial Invoice	Tender Rate of Exchange	Calculation of Import Value			Summary		
						Local value of Imports	Freight costs to part of entry	All locally incurred landing costs & duties	Total landed cost and VAT	Tender City	Total imported value
(D20)	(D21)	(D22)	(D23)	(D24)	(D25)	(D26)	(D27)	(D28)	(D29)	(D30)	(D31)
										(D32) Total imported value by tenderer	R 0

C. Imported by a 3rd party and supplied to the Tenderer

Description of imported content	Unit of measure	Local supplier	Overseas Supplier	Foreign currency value of per Commercial Invoice	Tender Rate of Exchange	Calculation of Import Value			Summary		
						Local value of Imports	Freight costs to part of entry	All locally incurred landing costs & duties	Total landed cost and VAT	Quantity Imported	Total imported value
(D33)	(D34)	(D35)	(D36)	(D37)	(D38)	(D39)	(D40)	(D41)	(D42)	(D43)	(D44)
										(D45) Total imported value by 3rd party	R 0

D. Other foreign currency payments

Type of payment	Local supplier making the payment	Overseas beneficiary	Calculation of foreign currency payments		Local value of payments
			Foreign currency value paid	Tender Rate of Exchange	
(D46)	(D47)	(D48)	(D49)	(D50)	(D51)

(D52) Total of foreign currency payments declared by tenderer and/or 3rd party
 (D53) Total of imported content & foreign currency payments - (D32), (D45) & (D51)

Date: _____

