

KZN Health > Components > Supply Chain Management

AdvertQuote



KWAZULU-NATAL PROVINCE
HEALTH
REPUBLIC OF SOUTH AFRICA

Quotation Advert

Opening Date: 2022-09-09

Closing Date: 2022-09-15

Closing Time: 11:00

INSTITUTION DETAILS

Institution Name: St Apollinaris hospital

Province: KwaZulu-Natal

Department or Entity: Department of Health

Division or section: Central Supply Chain Management

Place where goods / services is required St Apollinaris Hospital

Date Submitted 2022-09-09

ITEM CATEGORY AND DETAILS

Quotation Number: ZNQ: SAP108/2022/2023

Item Category: Goods

Item Description: SUPPLY AND DELIVER DOMESTIC EQUIPMENT AS PER ATTACHED

Quantity (if supplies) DIFFERENT QUANTITIES

COMPULSORY BRIEFING SESSION / SITE VISIT

Select Type: Not Applicable

Date :

Time:

Venue:

QUOTES CAN BE COLLECTED FROM: WEBSITE

QUOTES SHOULD BE DELIVERED TO: SECURITY OFFICE TENDER BOX

ENQUIRIES REGARDING THE ADVERT MAY BE DIRECTED TO:

Name: MN SOKHELA

Email:

Contact Number: 039-8339001/5

Finance Manager Name:

Mrs M.B Kheswa

Finance Manager Signature:



No late quotes will be considered

OFFICIAL PRICE PAGE FOR QUOTATIONS OVER R30 000

QUOTE NUMBER: SAP108/2022/2023

DESCRIPTION: SUPPLY AND DELIVER DOMESTIC EQUIPMENT

SIGNATURE OF BIDDER DATE
 [By signing this document, I hereby agree to all terms and conditions]

CAPACITY UNDER WHICH THIS QUOTE IS SIGNED

Item No	Quantity	Description	Brand & model	Country of manufacture	Price	
					R	c
	06 UNITS	SUPPLY AND DELIVER HIGH HEAT INSERT AND LID ,65MM HIGH HEAT (AMBER) 3.4L NB: SEE ATTACHED SAMPLE				
	200 EACH	SUPPLY AND DELIVER DOME COVER 230MM AND BASE 230MM MIDNIGHT BLUE COLOUR				
	04 UNITS	SUPPLY AND DELIVER DURABLE PLASTIC FOLDABLE TABLE WITH METAL LEGS WHITE 120CMX90CM				
	04 UNITS	SUPPLY AND DELIVER DURABLE FOLDABLE TABLE METAL LEGS WHITE 120CMX60CM				
	04 UNITS	SUPPLY AND DELIVER FRIDGE 240L GREY COLOUR				
	05 UNITS	SUPPLY AND DELIVER FRIDGE 614L GREY COLOUR				
	03 UNITS	SUPPLY AND DELIVER DEEP FREEZER 420L GREY IN COLOUR NB: GUARANTEE OF FRIDGE AND FREEZER MUST MINIMUM OF 2 YEARS				
	01 UNIT	SUPPLY AND DELIVER WRINGER METAL GEAR PRESS NB: PLEASE SEE ATTACHED SAMPLE PICTURE PLEASE SIGN TERMS OF REFERENCE WHERE IT IS				
VALUE ADDED TAX @ 15% (Only if VAT Vendor) REQUIRED						
TOTAL QUOTATION PRICE (VALIDITY PERIOD 60 Days)						

Does This Offer Comply With The Specification?	Does The Article Conform To The S.A.N.S. / S.A.B.S. Specification?
Is The Price Firm?	State Delivery Period, e.g., 1day, 1week

<p>Enquiries regarding the <u>quote</u> may be directed to:</p> <p>Contact Person: MN SOKHELA Tel: 0398339001</p> <p>E-Mail Address:</p>	<p>Enquiries regarding <u>technical information</u> may be directed to:</p> <p>Contact Person: NM MAHLABA Tel: 0398339001/2</p>
--	---

SPECIAL CONTRACT CONDITIONS OF QUOTATIONS

1. AMENDMENT OF CONTRACT

- 1.1. Any amendment to or renunciation of the provisions of the contract shall at all times be done in writing and shall be signed by both parties.

2. CHANGE OF ADDRESS

- 2.1. Bidders must advise the Department of Health (institution where the offer was submitted) should their address (*domicilium citandi et executandi*) details change from the time of bidding to the expiry of the contract.

3. GENERAL CONDITIONS ATTACHED TO THIS QUOTATION

- 3.1. The Department is under no obligation to accept the lowest or any quote.
- 3.2. The Department reserves the right to communicate in writing with vendors in cases where information is incomplete or where there are obscurities regarding technical aspects of the offer, to obtain confirmation of prices or preference claims in cases where it is evident that a typing, written, transfer or unit error has been made, to investigate the vendor's standing and ability to complete the supply/service satisfactorily.
- 3.3. **ALL DECISIONS TAKEN BY THE DEPARTMENT ARE FINAL, INCLUDING THE AWARD OR CANCELLATION OF THIS QUOTATION.**
- 3.4. The price quoted must include VAT (if VAT vendor).
- 3.5. Should a bidder become a VAT vendor after award or during the implementation of a contract, they may not request the VAT percentage from the Department as the service provider made an offer during the period they were not registered as a VAT vendor. The Department is only liable for any VAT from registered VAT vendors as originally stated on the quotation document.
- 3.6. The bidder must ensure the correctness & validity of the quotation:
 (i) *that the price(s), rate(s) & preference quoted cover all for the work/item (s) & accept that any mistakes regarding the price (s) & calculations will be at the bidder's risk*
 (ii) *it is the responsibility of the bidder to confirm receipt of their quotation and to keep proof thereof.*
- 3.7. The bidder must accept full responsibility for the proper execution & fulfilment of all obligations conditions devolving on under this agreement, as the Principal (s) liable for the due fulfilment of this contract.
- 3.8. This quotation will be evaluated based on the 80/20 points system, specification, correctness of information and/or functionality criteria. All required documentation must be completed in full and submitted.
- 3.9. Offers must comply strictly with the specification.
- 3.10. Only offers that meet or are greater than the specification will be considered.
- 3.11. Late offers will not be considered.
- 3.12. Expired product/s will not be accepted. All products supplied must be valid for a minimum period of six months.
- 3.13. Used/ second-hand products will not be accepted.
- 3.14. A bidder not registered on the Central Suppliers Database or whose verification has failed will not be considered.
- 3.15. All delivery costs must be included in the quoted price for delivery at the prescribed destination.
- 3.16. Only firm prices will be accepted. Such prices must remain firm for the contract period. Non-firm prices (including rates of exchange variations) will not be considered.
- 3.17. In cases where different delivery points influence the pricing, a separate pricing schedule must be submitted for each delivery point.
- 3.18. In the event of a bidder having multiple quotes, only the cheapest according to specification will be considered.
- 3.19. Verification will be conducted to identify if bidders have multiple companies and are cover-quoting for this bid.
- 3.20. In such instances, the Department reserves the right to immediately disqualify such bidders as cover-quoting is an offence that represents both corruption and acquisition fraud.

4. SPECIAL INSTRUCTIONS AND NOTICES TO BIDDERS REGARDING THE COMPLETION OF THIS QUOTATION.

- 4.1. Unless inconsistent with or expressly indicated otherwise by the context, the singular shall include the plural and vice versa and with words importing the masculine gender shall include the feminine and the neuter.
- 4.2. Under no circumstances whatsoever may the quotation/bid forms be retyped or redrafted. Photocopies of the original bid documentation may be used, but an original signature must appear on such photocopies.
- 4.3. The bidder is advised to check the number of pages and to satisfy himself that none are missing or duplicated.
- 4.4. Quotations submitted must be complete in all respects. However, where it is identified that information in a bidder's response, which does not affect the preference points or price, is incomplete in any respect, the said supplier meets all specification requirements and scores the highest points in terms of preference points and price, the Department reserves the right to request the bidder to complete/ submit such information.
- 4.5. Any alteration made by the bidder must be initialled; failure to do so may render the response invalid.
- 4.6. Use of correcting fluid is prohibited and may render the response invalid.
- 4.7. Quotations will be opened in public as soon as practicable after the closing time of quotation.
- 4.8. Where practical, prices are made public at the time of opening quotations.
- 4.9. If it is desired to make more than one offer against any individual item, such offers should be given on a photocopy of the page in question. Clear indication thereof must be stated on the schedules attached.

4.10. The Department is under no obligation to pay suppliers in part for work done if the supplier can no longer for fulfil their obligation.

5. SPECIAL INSTRUCTIONS REGARDING HAND DELIVERED QUOTATIONS

- 5.1. Quotation shall be lodged at the address indicated not later than the closing time specified for their receipt, and in accordance with the directives in the quotation documents.
- 5.2. Each quotation shall be addressed in accordance with the directives in the quotation documents and shall be lodged in a separate sealed envelope, with the name and address of the bidder, the quotation number and closing date indicated on the envelope. The envelope shall not contain documents relating to any quotation other than that shown on the envelope. If this provision is not complied with, such quotations/bids may be rejected as being invalid.
- 5.3. All quotations received in sealed envelopes with the relevant quotation numbers on the envelopes are kept unopened in safe custody until the closing time of the quotation/bids. Where, however, a quotation is received open, it shall be sealed. If it is received without a quotation/bid number on the envelope, it shall be opened, the quotation number ascertained, the envelope sealed and the quotation number written on the envelope.
- 5.4. A specific box is provided for the receipt of quotations, and no quotation found in any other box or elsewhere subsequent to the closing date and time of quotation will be considered.
- 5.5. No quotation/bid sent through the post will be considered if it is received after the closing date and time stipulated in the quotation documentation, and proof of posting will not be accepted as proof of delivery.
- 5.6. Quotation documents must not be included in packages containing samples. Such quotations may be rejected as being invalid.

6. SAMPLES

- 6.1. In the case of the quote document stipulating that samples are required, the supplier will be informed in due course when samples should be provided to the institution. (This decreases the time of safety and storage risk that may be incurred by the respective institution). The bidders sample will be retained if such bidder wins the contract.
 - (i) If a company/s who has not won the quote requires their samples, they must advise the institution in writing of such.
 - (ii) If samples are not collected within three months of close of quote the institution reserves the right to dispose of them at their discretion.
- 6.2. **Samples must be made available when requested in writing or if stipulated on the document.**
 - (i) If a Bidder fails to provide a sample of their product on offer for scrutiny against the set specification when requested, their offer will be rejected. All testing will be for the account of the bidder.

7. COMPULSORY SITE INSPECTION / BRIEFING SESSION

- 7.1. Bidders who fail to attend the compulsory meeting will be disqualified from the evaluation process.
 - (i) The institution has determined that a compulsory site meeting take place.
 - (ii) Date ____/____/____ Time ____:____ Place _____

Institution Stamp:	Institution Site Inspection / briefing session Official Full Name: Signature: Date:
--------------------	--

8. STATEMENT OF SUPPLIES AND SERVICES

8.1. The contractor shall, when requested to do so, furnish particulars of supplies delivered or services executed. If he/she fails to do so, the Department may, without prejudice to any other rights which it may have, institute inquiries at the expense of the contractor to obtain the required particulars.

9. SUBMISSION AND COMPLETION OF SBD 6.1

9.1. Should a bidder wish to qualify for preference points they must complete a SBD 6.1 document. Failure by a bidder to provide all relevant information required, will result in such a bidder not being considered for preference point's allocation. The preferences applicable on the closing date will be utilized. Any changes after the closing date will not be considered for that particular quote.

10. TAX COMPLIANCE REQUIREMENTS

- 10.1. In the event that the tax compliance status has failed on CSD, *it is the suppliers' responsibility to provide a SARS pin in order for the institution to validate the tax compliance status of the supplier.*
- 10.2. In the event that the institution cannot validate the suppliers' tax clearance on SARS as well as the Central Suppliers Database, *the quote will not be considered and passed over as non-compliant according to National Treasury Instruction Note 4 (a) 2016/17.*

TAX INVOICE

10.3. A tax invoice shall be in the currency of the Republic of South Africa and shall contain the following particulars:

- | | |
|--|--|
| (i) the name, address and registration number of the supplier; | (iv) a description and quantity or volume of the goods or services supplied; |
| (ii) the name and address of the recipient; | (v) the official department order number issued to the supplier; |
| (iii) an individual serialized number and the date upon which the tax invoice is issued; | (vi) the value of the supply, the amount of tax charged; |
| | (vii) the words tax invoice in a prominent place. |

11. PATENT RIGHTS

The supplier shall indemnify the **KZN Department of Health** (hereafter known as the purchaser) against all third-party claims of infringement of patent, trademark, or industrial design rights arising from use of the goods or any part thereof by the purchaser.

12. PENALTIES

- 12.1. If at any time during the contract period, the service provider is unable to perform in a timely manner, the service provider must notify the institution in writing/email of the cause of and the duration of the delay. Upon receipt of the notification, the institution should evaluate the circumstances and, if deemed necessary, the institution may extend the service provider's time for performance.
- 12.2. In the event of delayed performance that extends beyond the delivery period, the institution is entitled to purchase commodities of a similar quantity and quality as a substitution for the outstanding commodities, without terminating the contract, as well as return commodities delivered at a later stage at the service provider's expense.
- 12.3. Alternatively, the institution may elect to terminate the contract and procure the necessary commodities in order to complete the contract. In the event that the contract is terminated the institution may claim damages from the service provider in the form of a penalty. The service provider's performance should be captured on the service provider database in order to determine whether or not the service provider should be awarded any contracts in the future.
- 12.4. If the supplier fails to deliver any or all of the goods or to perform the services within the period(s) specified in the contract, the purchaser shall, without prejudice to its other remedies under the contract, deduct from the contract price, as a penalty, a sum calculated on the delivered price of the delayed goods or unperformed services using the current prime interest rate calculated for each day of the delay until actual delivery or performance.

13. TERMINATION FOR DEFAULT

- 13.1. The purchaser, without prejudice to any other remedy for breach of contract, by written notice of default sent to the supplier, may terminate this contract in whole or in part:
- (i) if the supplier fails to deliver any or all of the goods within the period(s) specified in the contract,
 - (ii) if the supplier fails to perform any other obligation(s) under the contract; or
 - (iii) if the supplier, in the judgment of the purchaser, has engaged in corrupt or fraudulent practices in competing for or in executing the contract.
- 13.2. In the event the purchaser terminates the contract in whole or in part, the purchaser may procure, upon such terms and in such manner as it deems appropriate, goods, works or services similar to those undelivered, and the supplier shall be liable to the purchaser for any excess costs for such similar goods, works or services.
- 13.3. Where the purchaser terminates the contract in whole or in part, the purchaser may decide to impose a restriction penalty on the supplier by prohibiting such supplier from doing business with the public sector for a period not exceeding 10 years.

14. THE DEPARTMENT RESERVES THE RIGHT TO PASS OVER ANY QUOTATION WHICH FAILS TO COMPLY WITH THE ABOVE.

PREFERENCE POINTS CLAIM FORM IN TERMS OF THE PREFERENTIAL PROCUREMENT REGULATIONS 2017

This preference form must form part of all quotes invited. It contains general information and serves as a claim form for preference points for Broad-Based Black Economic Empowerment (B-BBEE) Status Level of Contribution

NB: BEFORE COMPLETING THIS FORM, BIDDERS MUST STUDY THE GENERAL CONDITIONS, DEFINITIONS AND DIRECTIVES APPLICABLE IN RESPECT OF B-BBEE, AS PRESCRIBED IN THE PREFERENTIAL PROCUREMENT REGULATIONS, 2017.

1. GENERAL CONDITIONS

- 1.1 The following preference point systems are applicable to all quotes:
- the 80/20 system for requirements with a Rand value of up to R50 000 000 (all applicable taxes included); and
- 1.2 The value of this quote is estimated to not exceed R50 000 000 (all applicable taxes included) and therefore the 80/20 preference point system shall be applicable.
- 1.3 Points for this quote shall be awarded for:
- (a) Price; and
 - (b) B-BBEE Status Level of Contributor.
- 1.4 The maximum points for this quote is allocated as follows:

	POINTS
PRICE	80
B-BBEE STATUS LEVEL OF CONTRIBUTOR	20
Total points for Price and B-BBEE must not exceed	100

- 1.5 Failure on the part of a bidder to submit proof of B-BBEE Status level of contributor together with the quote, will be interpreted to mean that preference points for B-BBEE status level of contribution are not claimed.
- 1.6 The purchaser reserves the right to require of a bidder, either before a quote is adjudicated or at any time subsequently, to substantiate any claim in regard to preferences, in any manner required by the purchaser.

2. DEFINITIONS

- (a) **"B-BBEE"** means broad-based black economic empowerment as defined in section 1 of the Broad-Based Black Economic Empowerment Act;
- (b) **"B-BBEE status level of contributor"** means the B-BBEE status of an entity in terms of a code of good practice on black economic empowerment, issued in terms of section 9(1) of the Broad-Based Black Economic Empowerment Act;
- (c) **"bid"** means a written offer in a prescribed or stipulated form in response to an invitation by an organ of state for the provision of goods or services, through price quotations, advertised competitive bidding processes or proposals;
- (d) **"Broad-Based Black Economic Empowerment Act"** means the Broad-Based Black Economic Empowerment Act, 2003 (Act No. 53 of 2003);
- (e) **"EME"** means an Exempted Micro Enterprise in terms of a code of good practice on black economic empowerment issued in terms of section 9 (1) of the Broad-Based Black Economic Empowerment Act;
- (f) **"functionality"** means the ability of a tenderer to provide goods or services in accordance with specifications as set out in the tender documents.
- (g) **"prices"** includes all applicable taxes less all unconditional discounts;
- (h) **"proof of B-BBEE status level of contributor"** means:
 - 1) B-BBEE Status level certificate issued by an authorized body or person;
 - 2) A sworn affidavit as prescribed by the B-BBEE Codes of Good Practice;
 - 3) Any other requirement prescribed in terms of the B-BBEE Act;
- (i) **"QSE"** means a qualifying small business enterprise in terms of a code of good practice on black economic empowerment issued in terms of section 9 (1) of the Broad-Based Black Economic Empowerment Act;
- (j) **"rand value"** means the total estimated value of a contract in Rand, calculated at the time of bid invitation, and includes all applicable taxes;

3. POINTS AWARDED FOR PRICE

3.1 THE 80/20 PREFERENCE POINT SYSTEMS

A maximum of 80 points is allocated for price on the following basis:

$$P_s = 80 \left(1 - \frac{P_t - P_{\min}}{P_{\min}} \right) \text{ Where}$$

- Ps = Points scored for price of bid under consideration
- Pt = Price of bid under consideration
- Pmin = price of lowest acceptable bid

4. POINTS AWARDED FOR B-BBEE STATUS LEVEL OF CONTRIBUTOR

4.1 In terms of Regulation 6 (2) and 7 (2) of the Preferential Procurement Regulations, preference points must be awarded to a bidder for attaining the B-BBEE status level of contribution in accordance with the table below:

B-BBEE Status Level of Contributor	Number of points (80/20 system)
1	20
2	18
3	14
4	12
5	8
6	6
7	4
8	2
Non-compliant contributor	0

5. BID DECLARATION

5.1 Bidders who claim points in respect of B-BBEE Status Level of Contribution must complete the following:

6. B-BBEE STATUS LEVEL OF CONTRIBUTOR CLAIMED IN TERMS OF PARAGRAPHS 1.4 AND 4.1

6.1 B-BBEE Status Level of Contributor: =(maximum of 20 points)

(Points claimed in respect of paragraph 7.1 must be in accordance with the table reflected in paragraph 4.1 and must be substantiated by relevant proof of B-BBEE status level of contributor.

7. SUB-CONTRACTING
(applicable box)

(Tick

YES		NO	
-----	--	----	--

7.1 Will any portion of the contract be sub-contracted?

7.1.1 If yes, indicate:

- i) What percentage of the contract will be subcontracted.....%
- ii) The name of the sub-contractor.....
- iii) The B-BBEE status level of the sub-contractor.....

8. Whether the sub-contractor is an EME or QSE

(Tick applicable box)

iv) Specify, by ticking the appropriate box, if subcontracting with an enterprise in terms of Preferential Procurement Regulations,2017:

YES		NO	
-----	--	----	--

Designated Group: An EME or QSE which is at least 51% owned by:	EME	QSE
Black people	√	√
Black people who are youth		
Black people who are women		
Black people with disabilities		
Black people living in rural or underdeveloped areas or townships		
Cooperative owned by black people		
Black people who are military veterans		
OR		
Any EME		
Any QSE		

9. **DECLARATION WITH REGARD TO COMPANY/FIRM**

9.1 Name of company/firm:.....

9.2 VAT registration number:.....

9.3 Company registration number:.....

9.4 **TYPE OF COMPANY/ FIRM [TICK APPLICABLE BOX]**

- Partnership/Joint Venture / Consortium
- One person business/sole propriety
- Close corporation
- Company
- (Pty) Limited

9.5 **DESCRIBE PRINCIPAL BUSINESS ACTIVITIES**

.....
.....

9.6 **COMPANY CLASSIFICATION [TICK APPLICABLE BOX]**

- Manufacturer
- Supplier
- Professional service provider
- Other service providers, e.g. transporter, etc.

9.7 Total number of years the company/firm has been in business:.....

9.8 I/we, the undersigned, who is / are duly authorised to do so on behalf of the company/firm, certify that the points claimed, based on the B-BBE status level of contributor indicated in paragraphs 1.4 and 6.1 of the foregoing certificate, qualifies the company/ firm for the preference(s) shown and I / we acknowledge that:

- i) The information furnished is true and correct;
- ii) The preference points claimed are in accordance with the General Conditions as indicated in paragraph 1 of this form;
- iii) In the event of a contract being awarded as a result of points claimed as shown in paragraphs 1.4 and 6.1, the contractor may be required to furnish documentary proof to the satisfaction of the purchaser that the claims are correct;
- iv) If the B-BBEE status level of contributor has been claimed or obtained on a fraudulent basis or any of the conditions of contract have not been fulfilled, the purchaser may, in addition to any other remedy it may have –
 - (a) disqualify the person from the bidding process;
 - (b) recover costs, losses or damages it has incurred or suffered as a result of that person's conduct;
 - (c) cancel the contract and claim any damages which it has suffered as a result of having to make less favourable arrangements due to such cancellation;
 - (d) recommend that the bidder or contractor, its shareholders and directors, or only the shareholders and directors who acted on a fraudulent basis, be restricted by the National Treasury from obtaining business from any organ of state for a period not exceeding 10 years, after the *audi alteram partem* (hear the other side) rule has been applied; and
 - (e) forward the matter for criminal prosecution.

WITNESSES
1.
2.

..... SIGNATURE(S) OF BIDDERS(S)
DATE:
ADDRESS.....

OVER 230



health

Department:
Health
PROVINCE OF KWAZULU-NATAL

St. Apollinaris hospital
Off Centocow main road, Centocow, CREIGHTON, 3263
Private Bag 206, Creighton, 3263
Tel.: 039 833 8085, Fax.: 039 833 8054
Email: mpe.malinga@kznhealth.gov.za
www.kznhealth.gov.za

SUPPLY CHAIN MANAGEMENT

Date: 23 August 2022

ZNQ Number: SAP 108/2000/2022

TERMS OF REFERENCE

Item Specification: Supply and deliver high heart insert and lid, 65mm high heat (amber) 3.4lt. see attached sample picture. Dome cover 230mm and base 230mm X 200 each X06 units
Midnight blue in colour

Name & Surname	Designation	Signature
CS Mbanjwa	SMO	
TA Mkhize	CPC-QAM	
M Mntungwana	OMN	
MI Ntshangase	SCC	
KO Shere	OMN	

SPECIFICATION TERMS AND CONDITIONS

- Only bidders that fully meet the specification shall be considered
- The institution is under no obligation to accept the lowest or any quote
- The quality of products must be SABS / SANS/ CKS approved and a certificate of compliance must be submitted when required
- The bidder must ensure the correctness and validity quote: the prices, rates & preference quoted cover all of the work and accept that any mistake regarding with the price calculations will be at the bidder's risk
- If the information supplied is found to be incorrect or false then the KZN department of Health, in addition to the remedies it may have, may recover from the contractor all cost, losses and damages incurred by the department as a result of the award of the contract, and / or cancel the contract and claim any damages
- Defaulting suppliers in terms of delivering, will be dealt with and will be reported at Treasury
- The evaluation criteria for the quotation above R30 000 will be 80/20 for the price and points certified BBBEE certificates and original tax clearance
- Incomplete declaration of interest and quotation form will not be considered
- Orders will be cancelled if the supplier fail to meet the set standards and lead time
- All quotations requiring registration with certain Bodies must be returned together with the following:
 - Valid tax clearance
 - Proof of registration with CSD
 - CK certificate / Cipro certificate
 - CIDB registration and grading with relevant job category
 - Reference letter (from where the supplier did the same job successfully)
 - Letter of good standing
 - Current proof of registration with relevant bodies
 - Sworn statement
- All conditions indicated in the quotation form will be applicable upon evaluation, and should be attached to evaluation criteria
- Quotation form must be completed and signed in full, any omissions or incomplete information and signatures will automatically disqualify the quotation
- Bill of quantity should be fully completed and all segments must be filled per item
- A guarantee / warrantee must be provided on appliances, services and repairs
- All these conditions are binding and service providers must comply with
- Samples must be provided with documents unless indicated otherwise
- For services requiring site inspection, no late bidders will be allowed to join briefing
- It is advisable to get all necessary information before quotation closing date

Chairperson
23/08/2022
Date

End user
23/08/22
Date

CEO
2022/08/24
Date

Storage and Handling

HIGH HEAT INSERTS AND LIDS

IMPROVED

CARLISLE
FOODSERVICE PRODUCTS



SPECIFICATIONS

- Not suitable for direct heat
- Single container solution for:
 - - Cold storage
 - - Blast freezin
 - - Microwave pre-heat / cooking
 - - Steam table applications
- Dishwasher safe
- Cook and store
- BPA Free

DESCRIPTION OF MEASUREMENTS - FULL - 530 x 325mm

INF8065 INSERT - FULL 65mm HIGH HEAT (AMBER) 7.2Lt

INF0365 INSERT - FULL 65mm HIGH HEAT (BLACK) 7.2Lt

INF8100 INSERT - FULL 100mm HIGH HEAT (AMBER) 12Lt

INF0300 INSERT - FULL 100mm HIGH HEAT (BLACK) 12Lt

INF8002 INSERT - FULL LID NOTCHED HIGH HEAT (AMBER)

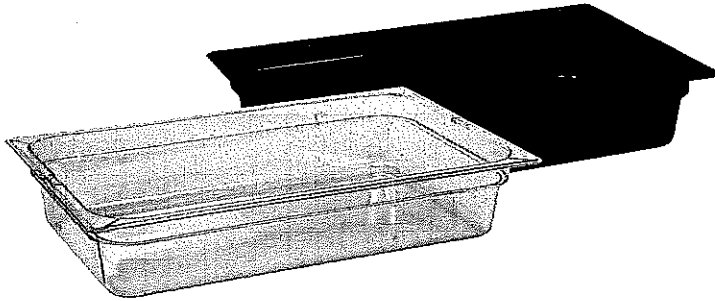

DESCRIPTION OF MEASUREMENTS - HALF - 530 x 265mm

INH8065 INSERT - HALF 65mm HIGH HEAT (AMBER) 3.4Lt

INH0365 INSERT - HALF 65mm HIGH HEAT (BLACK) 3.4Lt

INH8002 INSERT - HALF LID NOTCHED HIGH HEAT (AMBER)

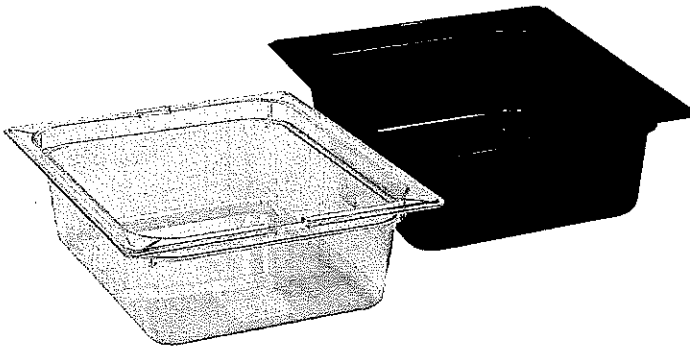

DESCRIPTION OF MEASUREMENTS - THIRD - 325 x 176mm

INT8065 INSERT - THIRD 65mm HIGH HEAT (AMBER) 2.7Lt

INT8002 INSERT - THIRD LID NOTCHED HIGH HEAT (AMBER)

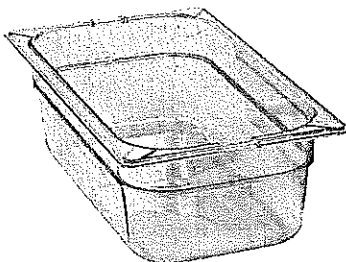

INSULATED LINE FROM DINEX® BY CARLISLE

FEATURES

- Guaranteed hot food
- Dishwasher safe
- Durable construction - polypropylene
- Superior heat retention
- Double wall construction - ozone friendly urethane foam insulation
- Disposable lids - hygienic and safe
- Holds temperature above 65°C for 45min
- Unique drip ring for removal of condensation
- Ideal for hospital, old age homes and clinics

TURNBURY RANGE

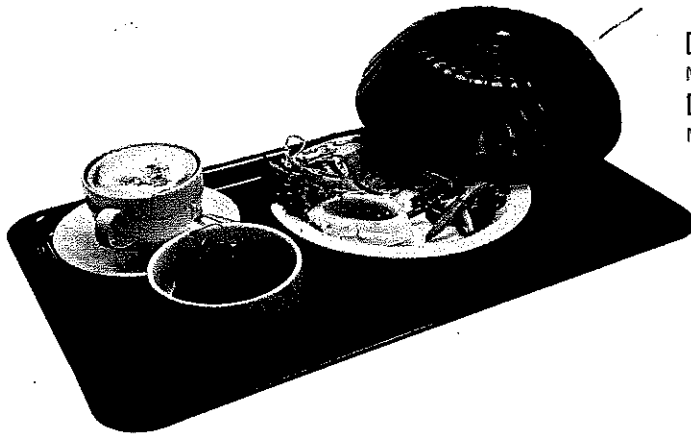

- DTD0001** DINEX TURNBURY INSULATED DOME COVER - 230mm ✓
MIDNIGHT BLUE
- DTB0230** DINEX TURNBURY INSULATED BASE - 230mm
MIDNIGHT BLUE



Classic Design Style
(Cranberry Colour)

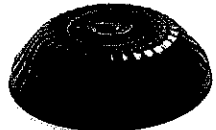

Turnbury Design Style
(Hunter Green Colour)

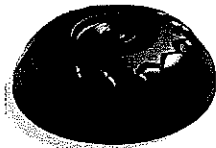

Fenwick Design Style
(Midnight Blue Colour)



INDENT COLOURS AVAILABLE ON REQUEST

- Onyx
- Cranberry
- Latte
- Hunter Green
- Plum

PLATE COVERS

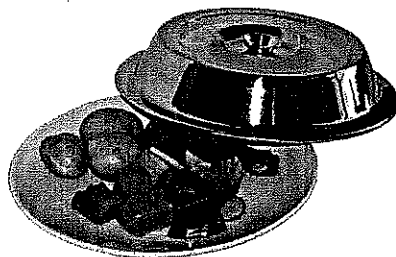

PCP280 PLATE COVER - S/STEEL - 260mm

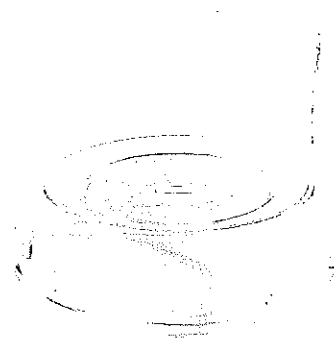

PCP2000 PLATE COVER POLYCARB - CLEAR
(FITS 230 and 250mm PLATES)

Global

Best Choice

DINEX INDUCTION - Smartherm

ation of induction heating systems. The Smart•Therm is the most innovative system for today's demanding foodservice
ons

e smallest footprint and weight
uction
for consistent and accurate temperatures



FEATURES

- Heat on demand
- Base activation in 14 secs
- 220V - Single phase
- Light weight and compact - 10.5kg
- Sealed units - moisture tight

IHD0002 INDUCTION HEATER - DINEX - SMART THERM 2 - 240V

DINEX INDUCTION - Bases







market
hip that relays information to the heating unit
om over-heating or excessive cycling, which causes
downtime for the trayline
high temperature rugged plastic and is seamless
ater intake

- Contains internal phase change material similar to a wax base that allows lower energy input to hold longer
- Bases can be reactivated any number of times, within any time frame "No need to wait"!
- Bases are stackable after heat activation
- Dinex Domes are compatible with induction bases

IHD0230

INDUCTION HEATER - DINEX - SMART THERM ✓
2-BASE - 230mm (MIDNIGHT BLUE)

INDENT COLOURS AVAILABLE ON REQUEST

- | | | |
|--|---|---|
|  Onyx |  Cranberry |  Sage |
|  Hunter Green |  Plum |  Latte |

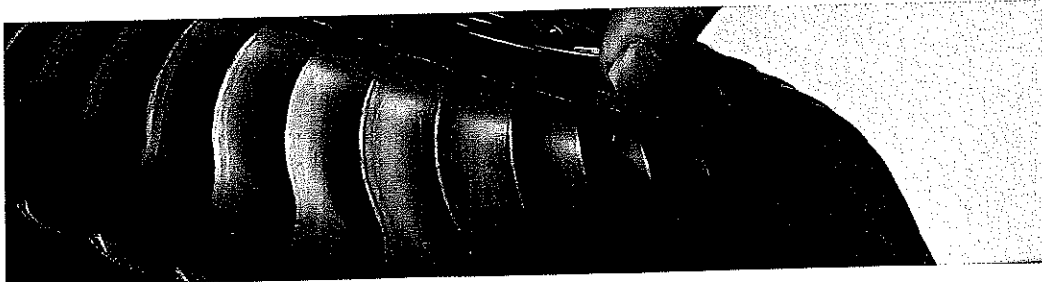

ON12
18/19



health

Department: Health PROVINCE OF KWAZULU-NATAL

St. Apollinaris hospital Off Centocow main road, Centocow, CREIGHTON, 3263 Private Bag 206, Greighton, 3263 Tel.: 039 833 8085, Fax.: 039 833 8054 Email.: mpe.malinga@kznhealth.gov.za www.kznhealth.gov.za

SUPPLY CHAIN MANAGEMENT

Date: 31 August 2022

ZNQ Number: SAP108/0000/0023

TERMS OF REFERENCE

Item Specification: Supply and deliver durable plastic foldable table with metal legs white 120cmx90cm. X04

Supply and deliver durable plastic foldable table metal legs white 120cmx60cm.04 UNITS

~~NB: Supplier to ensure that he submits filled local content together with quotation.~~

Table with 3 columns: Name & Surname, Designation, Signature. Rows include CS Mbanjwa (SMO), TA Mkhize (CPC-QAM), M Mntungwana (OMN), MI Ntshangase (SCC), LN Shezi (OMN).

SPECIFICATION TERMS AND CONDITIONS

- 1. Only bidders that fully meet the specification shall be considered
2. The institution is under no obligation to accept the lowest or any quote
3. The quality of products must be SABS / SANS/ CKS approved and a certificate of compliance must be submitted when required
4. The bidder must ensure the correctness and validity quote: the prices, rates & preference quoted cover all of the work and accept that any mistake regarding with the price calculations will be at the bidder's risk
5. If the information supplied is found to be incorrect or false then the KZN department of Health, in addition to the remedies it may have, may recover from the contractor all cost, losses and damages incurred by the department as a result of the award of the contract, and / or cancel the contract and claim any damages
6. Defaulting suppliers in terms of delivering, will be dealt with and will be reported at Treasury
7. The evaluation criteria for the quotation above R30 000 will be 80/20 for the price and points certified BBBEE certificates and original tax clearance
8. Incomplete declaration of interest and quotation form will not be considered
9. Orders will be cancelled if the supplier fail to meet the set standards and lead time
10. All quotations requiring registration with certain Bodies must be returned together with the following:
- Valid tax clearance
- Proof of registration with CSD
- CK certificate / Cipro certificate
- CIDB registration and grading with relevant job category
- Reference letter (from where the supplier did the same job successfully)
- Letter of good standing
- Current proof of registration with relevant bodies
- Sworn statement
11. All conditions indicated in the quotation form will be applicable upon evaluation, and should be attached to evaluation criteria
12. Quotation form must be completed and signed in full, any omissions or incomplete information and signatures will automatically disqualify the quotation
13. Bill of quantity should be fully completed and all segments must be filled per item
14. A guarantee / warrantee must be provided on appliances, services and repairs
15. All these conditions are binding and service providers must comply with
16. Samples must be provided with documents unless indicated otherwise
17. For services requiring site inspection, no late bidders will be allowed to join briefing
18. It is advisable to get all necessary information before quotation closing date

Chair Person: [Signature] Date: 31/08/2022
End user: [Signature] Date: 2022/08/31
CEO: [Signature] Date: 2022/09/01
Supplier's signature: _____ Date: _____



health

Department: Health PROVINCE OF KWAZULU-NATAL

St. Apollinaris hospital Off Centocow main road, Centocow, CREIGHTON, 3263 Private Bag 206, Creighton, 3263 Tel.: 039 833 8085, Fax.: 039 833 8054 Email.: mpe.malinga@kznhealth.gov.za www.kznhealth.gov.za

SUPPLY CHAIN MANAGEMENT

Date: 31 August 2022

ZNQ Number: SA108/0000/0003

TERMS OF REFERENCE

Item Specification: Supply and deliver wringer metal gear press. X01 NB: Please see attached sample picture

Table with 3 columns: Name & Surname, Designation, Signature. Rows include CS Mbanjwa (SMO), TA Mkhize (CPC-QAM), M Mtungwana (OMN), MI Ntshangase (SCC), LN Shezi (OMN).

SPECIFICATION TERMS AND CONDITIONS

- 1. Only bidders that fully meet the specification shall be considered
2. The institution is under no obligation to accept the lowest or any quote
3. The quality of products must be SABS / SANS/ CKS approved and a certificate of compliance must be submitted when required
... 18. It is advisable to get all necessary information before quotation closing date

Chairperson signature and date 2022/08/31

End user signature and date 2022/08/31

CEO signature and date 2022/09/01

Supplier's signature and date

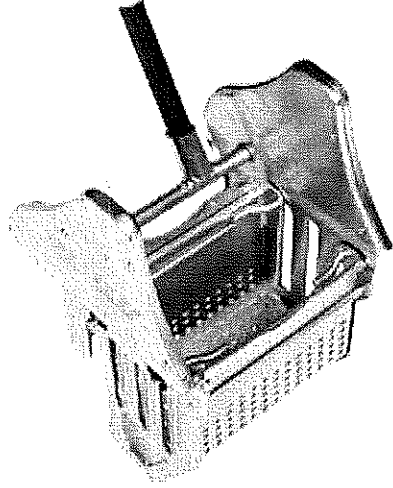



health

Department:
Health
PROVINCE OF KWAZULU-NATAL

St. Apollinaris hospital
Off Centocow main road, Centocow, CREIGHTON, 3263
Private Bag 206, Creighton, 3263
Tel.: 039 833 8085, Fax.: 039 833 8054
Email: mpe.malinga@kznhealth.gov.za
www.kznhealth.gov.za

SUPPLY CHAIN MANAGEMENT

Date: 23 August 2022

ZNQ Number: SAPI08/2022/2023

TERMS OF REFERENCE

Item Specification: Supply and deliver fridge 240L grey.X04

Supply and deliver fridge 614L grey. X05

Supply and deliver deep freezer 420L grey.X03

Guarantee must be a minimum of 2 years

NB: Supplier to ensure that he submits filled local content together with quotation.

Name & Surname	Designation	Signature
CS Mbanjwa	SMO	
TA Mkhize	CPC-QAM	
M Mntungwana	OMN	
MI Ntshangase	SCC	
LN Shezi	OMN	

SPECIFICATION TERMS AND CONDITIONS

- Only bidders that fully meet the specification shall be considered
- The institution is under no obligation to accept the lowest or any quote
- The quality of products must be SABS / SANS/ CKS approved and a certificate of compliance must be submitted when required
- The bidder must ensure the correctness and validity quote: the prices, rates & preference quoted cover all of the work and accept that any mistake regarding with the price calculations will be at the bidder's risk
- If the information supplied is found to be incorrect or false then the KZN department of Health, in addition to the remedies it may have, may recover from the contractor all cost, losses and damages incurred by the department as a result of the award of the contract, and / or cancel the contract and claim any damages
- Defaulting suppliers in terms of delivering, will be dealt with and will be reported at Treasury
- The evaluation criteria for the quotation above R30 000 will be 80/20 for the price and points certified BBBEE certificates and original tax clearance
- Incomplete declaration of interest and quotation form will not be considered
- Orders will be cancelled if the supplier fail to meet the set standards and lead time
- All quotations requiring registration with certain Bodies must be returned together with the following:
 - Valid tax clearance
 - Proof of registration with CSD
 - CK certificate / Cipro certificate
 - CIDB registration and grading with relevant job category
 - Reference letter (from where the supplier did the same job successfully)
 - Letter of good standing
 - Current proof of registration with relevant bodies
 - Sworn statement
- All conditions indicated in the quotation form will be applicable upon evaluation, and should be attached to evaluation criteria
- Quotation form must be completed and signed in full, any omissions or incomplete information and signatures will automatically disqualify the quotation
- Bill of quantity should be fully completed and all segments must be filled per item
- A guarantee / warrantee must be provided on appliances, services and repairs
- All these conditions are binding and service providers must comply with
- Samples must be provided with documents unless indicated otherwise
- For services requiring site inspection, no late bidders will be allowed to join briefing
- It is advisable to get all necessary information before quotation closing date

Chairperson
31/08/2022
Date

End user
01/09/22
Date

CEO
01/09/22
Date

Supplier's signature
Date