



**KWAZULU-NATAL PROVINCE**

HEALTH  
REPUBLIC OF SOUTH AFRICA

## Quotation Advert

**Opening Date:** 01/02/2023

**Closing Date:** 03/02/2023

**Closing Time:** 11:00

### INSTITUTION DETAILS

**Institution Name:** Tongaat CHC

**Province:** KwaZulu-Natal

**Department of entity:** Department of Health

**Division or section:** Central Supply Chain Management

**Place where goods/  
service is required:** Tongaat Community Health Centre

**Date Submitted:** 31/01/2023

### ITEM CATEGORY AND DETAILS

**Quotation number:** ZNQ: TON/153/22/23

**Item Category:** Goods

**Item Description:** Surgical instruments

**Quantity (if supplies):** N/A

### COMPULSORY BRIEFING SESSION / SITE VISIT

**Select Type:** Not applicable

**Date:** Click here to enter a date.

**Time:** Click here to enter text.

**Venue:** Click here to enter text.

**QUOTES CAN BE COLLECTED FROM:** 07 Sanele Nxumalo Lane Tongaat

**QUOTES SHOULD BE DELIVERED TO:** 07 Sanele Nxumalo Lane Tongaat 4399

### ENQUIRIES REGARDING ADVERT MAY BE DIRECTED TO:

**Name:** S. Ramcharan

**Email:** sivendra.ramcharan@kznhealth.gov.za

**Contact number:** 032 944 5054

**Finance Manager Name:** Ms. J. Phalad **Finance Manager Signature**



OFFICIAL PRICE PAGE FOR QUOTATIONS OVER R30 000

QUOTE NUMBER: TON/153/22/23

DESCRIPTION: Surgical instruments

SIGNATURE OF BIDDER ..... DATE.....  
 [By signing this document, I hereby agree to all terms and conditions]

CAPACITY UNDER WHICH THIS QUOTE IS SIGNED.....

Item No	Quantity	Description	Brand & model	Country of manufacture	Price	
					R	c
01.	X 40 Units	Large artery forcep				
02.	X 02 Units	Tenaculum / Valcelum				
03.	X 20 Units	Mayo dressing scissors s/s				
04.	X 20 Units	Stitch scissors				
05.	X 10 Units	Medium receiver				
06.	X 15 Units	Large receiver				
07.	X 10 Units	6" Bowls				
08.	X 24 Units	Bowl s/s approx. 240 mm diameter				
09.	X 20 Units	Disecting forceps non - toothed				
10.	X 20 Units	Disecting forceps - toothed				
11.	X 10 Units	Gallipots				
12.	X 10 Units	Mosquito forcep straight				
13.	X 10 Units	Mosquito forcep curved				
14.	X 10 Units	Episotomy scissors				
15.	X 20 Units	Cord scissors				
16.	X 10 Units	Needle holder long handle				
17.	X 10 Units	Artery forcep straight long medium				
18.	X 10 Units	Artery forcep curved long - medium				
19.	X 01 Unit	Magills adult				
20.	X 01 Unit	Magills paed				
21.	X 04 Units	Tray instruments washing with lid 183mm x 140 x 17mm				
22.	X 02 Units	Stainless steel large round bowl				
23.	X 02 Units	Rescue scissors				
24.	X 25 Units	Stainless steel S shaped hooks				
25.	X 01 Unit	Stainless steel large basin				
NB: Page 1 of 2						
VALUE ADDED TAX @ 15% (Only if VAT Vendor)						
TOTAL QUOTATION PRICE (VALIDITY PERIOD 60 Days)						

Does This Offer Comply With The Specification?	Does The Article Conform To The S.A.N.S. / S.A.B.S. Specification?
Is The Price Firm?	State Delivery Period, e.g., 1day, 1week

<p>Enquiries regarding the <u>quote</u> may be directed to:</p> <p>Contact Person: S. Ramcharan Tel: 032 944 5054</p> <p>E-Mail Address: sivendra.ramcharan@kznhealth.gov.za</p>	<p>Enquiries regarding <u>technical information</u> may be directed to:</p> <p>Contact Person: Ms. L.F.Magwaza Tel: 032 944 5054</p>
--	--

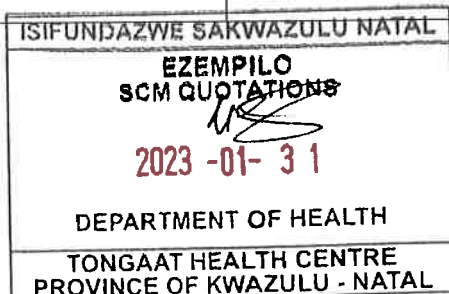



BIDDER'S DISCLOSURE

1. PURPOSE OF THE FORM

Any person (natural or juristic) may make an offer or offers in terms of this invitation to bid. In line with the principles of transparency, accountability, impartiality, and ethics as enshrined in the Constitution of the Republic of South Africa and further expressed in various pieces of legislation, it is required for the bidder to make this declaration in respect of the details required hereunder.

Where a person/s are listed in the Register for Tender Defaulters and / or the List of Restricted Suppliers, that person will automatically be disqualified from the bid process.

2. BIDDER'S DECLARATION

2.1. Is the bidder, or any of its directors / trustees / shareholders / members / partners or any person having a controlling interest<sup>1</sup> in the enterprise, employed by the state? YES/NO

2.1.1 If so, furnish particulars of the names, individual identity numbers, and, if applicable, state employee numbers of sole proprietor/directors / trustees / shareholders / members/ partners or any person having a controlling interest in the enterprise, in table below.

Table with 3 columns: Full Name, Identity Number, Name of State Institution

2.2. Do you, or any person connected with the bidder, have a relationship with any person who is employed by the procuring institution? YES/NO

2.2.1. If so, furnish particulars: .....

2.3. Does the bidder or any of its directors / trustees / shareholders / members / partners or any person having a controlling interest in the enterprise have any interest in any other related enterprise whether or not they are bidding for this contract? YES/NO

2.3.1. If so, furnish particulars: .....

3. DECLARATION

I, the undersigned,(name)..... in submitting the accompanying bid, do hereby make the following statements that I certify to be true and complete in every respect:

- 3.1. I have read and I understand the contents of this disclosure;
3.2. I understand that the accompanying bid will be disqualified if this disclosure is found not to be true and complete in every respect;
3.3. The bidder has arrived at the accompanying bid independently from, and without consultation, communication, agreement or arrangement with any competitor.
3.4. In addition, there have been no consultations, communications, agreements or arrangements with any competitor regarding the quality, quantity, specifications, prices, including methods, factors or formulas used to calculate prices, market allocation, the intention or decision to submit or not to submit the bid, bidding with the intention not to win the bid and conditions or delivery particulars of the products or services to which this bid invitation relates.
3.5. The terms of the accompanying bid have not been, and will not be, disclosed by the bidder, directly or indirectly, to any competitor, prior to the date and time of the official bid opening or of the awarding of the contract.
3.6. There have been no consultations, communications, agreements or arrangements made by the bidder with any official of the procuring institution in relation to this procurement process prior to and during the bidding process except to provide clarification on the bid submitted where so required by the institution; and the bidder was not involved in the drafting of the specifications or terms of reference for this bid.
3.7. I am aware that, in addition and without prejudice to any other remedy provided to combat any restrictive practices related to bids and contracts, bids that are suspicious will be reported to the Competition Commission for investigation and possible imposition of administrative penalties in terms of section 59 of the Competition Act No 89 of 1998 and or may be reported to the National Prosecuting Authority (NPA) for criminal investigation and or may be restricted from conducting business with the public sector for a period not exceeding ten (10) years in terms of the Prevention and Combating of Corrupt Activities Act No 12 of 2004 or any other applicable legislation.

I CERTIFY THAT THE INFORMATION FURNISHED IN PARAGRAPHS 1, 2 and 3 ABOVE IS CORRECT.
I ACCEPT THAT THE STATE MAY REJECT THE BID OR ACT AGAINST ME IN TERMS OF PARAGRAPH 6 OF PFMA SCM INSTRUCTION 03 OF 2021/22 ON PREVENTING AND COMBATING ABUSE IN THE SUPPLY CHAIN MANAGEMENT SYSTEM SHOULD THIS DECLARATION PROVE TO BE FALSE.

Name of Bidder Signature Position Date

1 the power, by one person or a group of persons holding the majority of the equity of an enterprise, alternatively, the person/s having the deciding vote or power to influence or to direct the course and decisions of the enterprise.
2 Joint venture or Consortium means an association of persons for the purpose of combining their expertise, property, capital, efforts, skill and knowledge in an activity for the execution of a contract.

## SPECIAL CONTRACT CONDITIONS OF QUOTATIONS

### 1. AMENDMENT OF CONTRACT

- 1.1. Any amendment to or renunciation of the provisions of the contract shall at all times be done in writing and shall be signed by both parties.

### 2. CHANGE OF ADDRESS

- 2.1. Bidders must advise the Department of Health (institution where the offer was submitted) should their address (*domicilium citandi et executandi*) details change from the time of bidding to the expiry of the contract.

### 3. GENERAL CONDITIONS ATTACHED TO THIS QUOTATION

- 3.1. The Department is under no obligation to accept the lowest or any quote.
- 3.2. The Department reserves the right to communicate in writing with vendors in cases where information is incomplete or where there are obscurities regarding technical aspects of the offer, to obtain confirmation of prices or preference claims in cases where it is evident that a typing, written, transfer or unit error has been made, to investigate the vendor's standing and ability to complete the supply/service satisfactorily.
- 3.3. **ALL DECISIONS TAKEN BY THE DEPARTMENT ARE FINAL, INCLUDING THE AWARD OR CANCELLATION OF THIS QUOTATION.**
- 3.4. The price quoted must include VAT (if VAT vendor).
- 3.5. Should a bidder become a VAT vendor after award or during the implementation of a contract, they may not request the VAT percentage from the Department as the service provider made an offer during the period they were not registered as a VAT vendor. The Department is only liable for any VAT from registered VAT vendors as originally stated on the quotation document.
- 3.6. The bidder must ensure the correctness & validity of the quotation:
- (i) *that the price(s), rate(s) & preference quoted cover all for the work/item (s) & accept that any mistakes regarding the price (s) & calculations will be at the bidder's risk*
- (ii) *it is the responsibility of the bidder to confirm receipt of their quotation and to keep proof thereof.*
- 3.7. The bidder must accept full responsibility for the proper execution & fulfilment of all obligations conditions devolving on under this agreement, as the Principal (s) liable for the due fulfilment of this contract.
- 3.8. This quotation will be evaluated based on the 80/20 points system, specification, correctness of information and/or functionality criteria. All required documentation must be completed in full and submitted.
- 3.9. Offers must comply strictly with the specification.
- 3.10. Only offers that meet or are greater than the specification will be considered.
- 3.11. Late offers will not be considered.
- 3.12. Expired product/s will not be accepted. All products supplied must be valid for a minimum period of six months.
- 3.13. Used/ second-hand products will not be accepted.
- 3.14. A bidder not registered on the Central Suppliers Database or whose verification has failed will not be considered.
- 3.15. All delivery costs must be included in the quoted price for delivery at the prescribed destination.
- 3.16. Only firm prices will be accepted. Such prices must remain firm for the contract period. Non-firm prices (including rates of exchange variations) will not be considered.
- 3.17. In cases where different delivery points influence the pricing, a separate pricing schedule must be submitted for each delivery point.
- 3.18. In the event of a bidder having multiple quotes, only the cheapest according to specification will be considered.
- 3.19. Verification will be conducted to identify if bidders have multiple companies and are cover-quoting for this bid.
- 3.20. In such instances, the Department reserves the right to immediately disqualify such bidders as cover-quoting is an offence that represents both corruption and acquisition fraud.

### 4. SPECIAL INSTRUCTIONS AND NOTICES TO BIDDERS REGARDING THE COMPLETION OF THIS QUOTATION.

- 4.1. Unless inconsistent with or expressly indicated otherwise by the context, the singular shall include the plural and vice versa and with words importing the masculine gender shall include the feminine and the neuter.
- 4.2. Under no circumstances whatsoever may the quotation/bid forms be retyped or redrafted. Photocopies of the original bid documentation may be used, but an original signature must appear on such photocopies.
- 4.3. The bidder is advised to check the number of pages and to satisfy himself that none are missing or duplicated.
- 4.4. Quotations submitted must be complete in all respects. However, where it is identified that information in a bidder's response, which does not affect the preference points or price, is incomplete in any respect, the said supplier meets all specification requirements and scores the highest points in terms of preference points and price, the Department reserves the right to request the bidder to complete/ submit such information.
- 4.5. Any alteration made by the bidder must be initialled; failure to do so may render the response invalid.
- 4.6. Use of correcting fluid is prohibited and may render the response invalid.
- 4.7. Quotations will be opened in public as soon as practicable after the closing time of quotation.
- 4.8. Where practical, prices are made public at the time of opening quotations.
- 4.9. If it is desired to make more than one offer against any individual item, such offers should be given on a photocopy of the page in question. Clear indication thereof must be stated on the schedules attached.

4.10. The Department is under no obligation to pay suppliers in part for work done if the supplier can no longer for fulfil their obligation.

**5. SPECIAL INSTRUCTIONS REGARDING HAND DELIVERED QUOTATIONS**

- 5.1. Quotation shall be lodged at the address indicated not later than the closing time specified for their receipt, and in accordance with the directives in the quotation documents.
- 5.2. Each quotation shall be addressed in accordance with the directives in the quotation documents and shall be lodged in a separate sealed envelope, with the name and address of the bidder, the quotation number and closing date indicated on the envelope. The envelope shall not contain documents relating to any quotation other than that shown on the envelope. If this provision is not complied with, such quotations/bids may be rejected as being invalid.
- 5.3. All quotations received in sealed envelopes with the relevant quotation numbers on the envelopes are kept unopened in safe custody until the closing time of the quotation/bids. Where, however, a quotation is received open, it shall be sealed. If it is received without a quotation/bid number on the envelope, it shall be opened, the quotation number ascertained, the envelope sealed and the quotation number written on the envelope.
- 5.4. A specific box is provided for the receipt of quotations, and no quotation found in any other box or elsewhere subsequent to the closing date and time of quotation will be considered.
- 5.5. No quotation/bid sent through the post will be considered if it is received after the closing date and time stipulated in the quotation documentation, and proof of posting will not be accepted as proof of delivery.
- 5.6. Quotation documents must not be included in packages containing samples. Such quotations may be rejected as being invalid.

**6. SAMPLES**

- 6.1. In the case of the quote document stipulating that samples are required, the supplier will be informed in due course when samples should be provided to the institution. (This decreases the time of safety and storage risk that may be incurred by the respective institution). The bidders sample will be retained if such bidder wins the contract.
  - (i) If a company/s who has not won the quote requires their samples, they must advise the institution in writing of such.
  - (ii) If samples are not collected within three months of close of quote the institution reserves the right to dispose of them at their discretion.
- 6.2. **Samples must be made available when requested in writing or if stipulated on the document.**
  - (i) If a Bidder fails to provide a sample of their product on offer for scrutiny against the set specification when requested, their offer will be rejected. All testing will be for the account of the bidder.

**7. COMPULSORY SITE INSPECTION / BRIEFING SESSION**

- 7.1. Bidders who fail to attend the compulsory meeting will be disqualified from the evaluation process.
  - (i) The institution has determined that a compulsory site meeting take place.
  - (ii) Date      /      /      Time      :      Place

Institution Stamp:	Institution Site Inspection / briefing session Official Full Name: ..... Signature: ..... Date: .....
--------------------	--

**8. STATEMENT OF SUPPLIES AND SERVICES**

8.1. The contractor shall, when requested to do so, furnish particulars of supplies delivered or services executed. If he/she fails to do so, the Department may, without prejudice to any other rights which it may have, institute inquiries at the expense of the contractor to obtain the required particulars.

**9. SUBMISSION AND COMPLETION OF SBD 6.1**

9.1. Should a bidder wish to qualify for preference points they must complete a SBD 6.1 document. Failure by a bidder to provide all relevant information required, will result in such a bidder not being considered for preference point's allocation. The preferences applicable on the closing date will be utilized. Any changes after the closing date will not be considered for that particular quote.

**10. TAX COMPLIANCE REQUIREMENTS**

- 10.1. In the event that the tax compliance status has failed on CSD, **it is the suppliers' responsibility to provide a SARS pin in order for the institution to validate the tax compliance status of the supplier.**
- 10.2. In the event that the institution cannot validate the suppliers' tax clearance on SARS as well as the Central Suppliers Database, **the quote will not be considered and passed over as non-compliant according to National Treasury Instruction Note 4 (a) 2016/17.**

## TAX INVOICE

10.3. A tax invoice shall be in the currency of the Republic of South Africa and shall contain the following particulars:

- (i) the name, address and registration number of the supplier;
- (ii) the name and address of the recipient;
- (iii) an individual serialized number and the date upon which the tax invoice is issued;
- (iv) a description and quantity or volume of the goods or services supplied;
- (v) the official department order number issued to the supplier;
- (vi) the value of the supply, the amount of tax charged;
- (vii) the words tax invoice in a prominent place.

## 11. PATENT RIGHTS

The supplier shall indemnify the **KZN Department of Health** (hereafter known as the purchaser) against all third-party claims of infringement of patent, trademark, or industrial design rights arising from use of the goods or any part thereof by the purchaser.

## 12. PENALTIES

- 12.1. If at any time during the contract period, the service provider is unable to perform in a timely manner, the service provider must notify the institution in writing/email of the cause of and the duration of the delay. Upon receipt of the notification, the institution should evaluate the circumstances and, if deemed necessary, the institution may extend the service provider's time for performance.
- 12.2. In the event of delayed performance that extends beyond the delivery period, the institution is entitled to purchase commodities of a similar quantity and quality as a substitution for the outstanding commodities, without terminating the contract, as well as return commodities delivered at a later stage at the service provider's expense.
- 12.3. Alternatively, the institution may elect to terminate the contract and procure the necessary commodities in order to complete the contract. In the event that the contract is terminated the institution may claim damages from the service provider in the form of a penalty. The service provider's performance should be captured on the service provider database in order to determine whether or not the service provider should be awarded any contracts in the future.
- 12.4. If the supplier fails to deliver any or all of the goods or to perform the services within the period(s) specified in the contract, the purchaser shall, without prejudice to its other remedies under the contract, deduct from the contract price, as a penalty, a sum calculated on the delivered price of the delayed goods or unperformed services using the current prime interest rate calculated for each day of the delay until actual delivery or performance.

## 13. TERMINATION FOR DEFAULT

- 13.1. The purchaser, without prejudice to any other remedy for breach of contract, by written notice of default sent to the supplier, may terminate this contract in whole or in part:
  - (i) if the supplier fails to deliver any or all of the goods within the period(s) specified in the contract,
  - (ii) if the supplier fails to perform any other obligation(s) under the contract; or
  - (iii) if the supplier, in the judgment of the purchaser, has engaged in corrupt or fraudulent practices in competing for or in executing the contract.
- 13.2. In the event the purchaser terminates the contract in whole or in part, the purchaser may procure, upon such terms and in such manner as it deems appropriate, goods, works or services similar to those undelivered, and the supplier shall be liable to the purchaser for any excess costs for such similar goods, works or services.
- 13.3. Where the purchaser terminates the contract in whole or in part, the purchaser may decide to impose a restriction penalty on the supplier by prohibiting such supplier from doing business with the public sector for a period not exceeding 10 years.

## 14. THE DEPARTMENT RESERVES THE RIGHT TO PASS OVER ANY QUOTATION WHICH FAILS TO COMPLY WITH THE ABOVE.



**PREFERENCE POINTS CLAIM FORM IN TERMS OF THE PREFERENTIAL PROCUREMENT REGULATIONS 2017**

This preference form must form part of all quotes invited. It contains general information and serves as a claim form for preference points for Broad-Based Black Economic Empowerment (B-BBEE) Status Level of Contribution

**NB: BEFORE COMPLETING THIS FORM, BIDDERS MUST STUDY THE GENERAL CONDITIONS, DEFINITIONS AND DIRECTIVES APPLICABLE IN RESPECT OF B-BBEE, AS PRESCRIBED IN THE PREFERENTIAL PROCUREMENT REGULATIONS, 2017.**

**1. GENERAL CONDITIONS**

- 1.1 The following preference point systems are applicable to all quotes:
- the 80/20 system for requirements with a Rand value of up to R50 000 000 (all applicable taxes included); and
- 1.2 The value of this quote is estimated to not exceed R50 000 000 (all applicable taxes included) and therefore the 80/20 preference point system shall be applicable.
- 1.3 Points for this quote shall be awarded for:
- (a) Price; and
  - (b) B-BBEE Status Level of Contributor.
- 1.4 The maximum points for this quote is allocated as follows:

	POINTS
<b>PRICE</b>	80
<b>B-BBEE STATUS LEVEL OF CONTRIBUTOR</b>	20
<b>Total points for Price and B-BBEE must not exceed</b>	100

- 1.5 Failure on the part of a bidder to submit proof of B-BBEE Status level of contributor together with the quote, will be interpreted to mean that preference points for B-BBEE status level of contribution are not claimed.
- 1.6 The purchaser reserves the right to require of a bidder, either before a quote is adjudicated or at any time subsequently, to substantiate any claim in regard to preferences, in any manner required by the purchaser.
- 2. DEFINITIONS**
- (a) **"B-BBEE"** means broad-based black economic empowerment as defined in section 1 of the Broad-Based Black Economic Empowerment Act;
  - (b) **"B-BBEE status level of contributor"** means the B-BBEE status of an entity in terms of a code of good practice on black economic empowerment, issued in terms of section 9(1) of the Broad-Based Black Economic Empowerment Act;
  - (c) **"bid"** means a written offer in a prescribed or stipulated form in response to an invitation by an organ of state for the provision of goods or services, through price quotations, advertised competitive bidding processes or proposals;
  - (d) **"Broad-Based Black Economic Empowerment Act"** means the Broad-Based Black Economic Empowerment Act, 2003 (Act No. 53 of 2003);
  - (e) **"EME"** means an Exempted Micro Enterprise in terms of a code of good practice on black economic empowerment issued in terms of section 9 (1) of the Broad-Based Black Economic Empowerment Act;
  - (f) **"functionality"** means the ability of a tenderer to provide goods or services in accordance with specifications as set out in the tender documents.
  - (g) **"prices"** includes all applicable taxes less all unconditional discounts;
  - (h) **"proof of B-BBEE status level of contributor"** means:
    - 1) B-BBEE Status level certificate issued by an authorized body or person;
    - 2) A sworn affidavit as prescribed by the B-BBEE Codes of Good Practice;
    - 3) Any other requirement prescribed in terms of the B-BBEE Act;
  - (i) **"QSE"** means a qualifying small business enterprise in terms of a code of good practice on black economic empowerment issued in terms of section 9 (1) of the Broad-Based Black Economic Empowerment Act;
  - (j) **"rand value"** means the total estimated value of a contract in Rand, calculated at the time of bid invitation, and includes all applicable taxes;

**3. POINTS AWARDED FOR PRICE**

**3.1 THE 80/20 PREFERENCE POINT SYSTEMS**

A maximum of 80 points is allocated for price on the following basis:

$$P_s = 80 \left( 1 - \frac{P_t - P_{\min}}{P_{\min}} \right) \text{ Where}$$

- P<sub>s</sub> = Points scored for price of bid under consideration
- P<sub>t</sub> = Price of bid under consideration
- P<sub>min</sub> = price of lowest acceptable bid

**4. POINTS AWARDED FOR B-BBEE STATUS LEVEL OF CONTRIBUTOR**

4.1 In terms of Regulation 6 (2) and 7 (2) of the Preferential Procurement Regulations, preference points must be awarded to a bidder for attaining the B-BBEE status level of contribution in accordance with the table below:

B-BBEE Status Level of Contributor	Number of points (80/20 system)
1	20
2	18
3	14
4	12
5	8
6	6
7	4
8	2
Non-compliant contributor	0

**5. BID DECLARATION**

5.1 Bidders who claim points in respect of B-BBEE Status Level of Contribution must complete the following:

**6. B-BBEE STATUS LEVEL OF CONTRIBUTOR CLAIMED IN TERMS OF PARAGRAPHS 1.4 AND 4.1**

6.1 B-BBEE Status Level of Contributor: = .....(maximum of 20 points)

(Points claimed in respect of paragraph 7.1 must be in accordance with the table reflected in paragraph 4.1 and must be substantiated by relevant proof of B-BBEE status level of contributor.)

**7. SUB-CONTRACTING**  
**applicable box)**

(Tick

YES	<input type="checkbox"/>	NO	<input type="checkbox"/>
-----	--------------------------	----	--------------------------

7.1 Will any portion of the contract be sub-contracted?

7.1.1 If yes, indicate:

- i) What percentage of the contract will be subcontracted.....%
- ii) The name of the sub-contractor.....
- iii) The B-BBEE status level of the sub-contractor.....

8. Whether the sub-contractor is an EME or QSE

(Tick applicable box)

iv) Specify, by ticking the appropriate box, if subcontracting with an enterprise in terms of Preferential Procurement Regulations, 2017:

YES	<input type="checkbox"/>	NO	<input type="checkbox"/>
-----	--------------------------	----	--------------------------

Designated Group: An EME or QSE which is at least 51% owned by:	EME √	QSE √
Black people	<input checked="" type="checkbox"/>	<input checked="" type="checkbox"/>
Black people who are youth	<input type="checkbox"/>	<input type="checkbox"/>
Black people who are women	<input type="checkbox"/>	<input type="checkbox"/>
Black people with disabilities	<input type="checkbox"/>	<input type="checkbox"/>
Black people living in rural or underdeveloped areas or townships	<input type="checkbox"/>	<input type="checkbox"/>
Cooperative owned by black people	<input type="checkbox"/>	<input type="checkbox"/>
Black people who are military veterans	<input type="checkbox"/>	<input type="checkbox"/>
OR		
Any EME	<input type="checkbox"/>	<input type="checkbox"/>
Any QSE	<input type="checkbox"/>	<input type="checkbox"/>

9. **DECLARATION WITH REGARD TO COMPANY/FIRM**

9.1 Name of company/firm:.....

9.2 VAT registration number:.....

9.3 Company registration number:.....

9.4 **TYPE OF COMPANY/ FIRM [TICK APPLICABLE BOX]**

- Partnership/Joint Venture / Consortium
- One person business/sole propriety
- Close corporation
- Company
- (Pty) Limited

9.5 **DESCRIBE PRINCIPAL BUSINESS ACTIVITIES**

.....  
.....

9.6 **COMPANY CLASSIFICATION [TICK APPLICABLE BOX]**

- Manufacturer
- Supplier
- Professional service provider
- Other service providers, e.g. transporter, etc.

9.7 Total number of years the company/firm has been in business:.....

9.8 I/we, the undersigned, who is / are duly authorised to do so on behalf of the company/firm, certify that the points claimed, based on the B-BBE status level of contributor indicated in paragraphs 1.4 and 6.1 of the foregoing certificate, qualifies the company/ firm for the preference(s) shown and I / we acknowledge that:

- i) The information furnished is true and correct;
- ii) The preference points claimed are in accordance with the General Conditions as indicated in paragraph 1 of this form;
- iii) In the event of a contract being awarded as a result of points claimed as shown in paragraphs 1.4 and 6.1, the contractor may be required to furnish documentary proof to the satisfaction of the purchaser that the claims are correct;
- iv) If the B-BBEE status level of contributor has been claimed or obtained on a fraudulent basis or any of the conditions of contract have not been fulfilled, the purchaser may, in addition to any other remedy it may have –
  - (a) disqualify the person from the bidding process;
  - (b) recover costs, losses or damages it has incurred or suffered as a result of that person's conduct;
  - (c) cancel the contract and claim any damages which it has suffered as a result of having to make less favourable arrangements due to such cancellation;
  - (d) recommend that the bidder or contractor, its shareholders and directors, or only the shareholders and directors who acted on a fraudulent basis, be restricted by the National Treasury from obtaining business from any organ of state for a period not exceeding 10 years, after the *audi alteram partem* (hear the other side) rule has been applied; and
  - (e) forward the matter for criminal prosecution.

WITNESSES
1. ....
2. ....

..... SIGNATURE(S) OF BIDDERS(S)
DATE: .....
ADDRESS..... ..... .....



Tongaat CHC, 07 Sanele Nxumalo Lane  
Tongaat  
4400  
Tel: 032 944 5054 Fax: 032 9451210. Email: Mondli.malunga@kznhealth.gov.za





Quotation Specification  
Committee

**TONGAAT COMMUNITY HEALTH CENTRE**

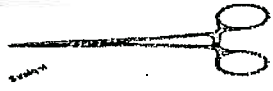

**SPEC NO: QSN TCHC \_\_\_\_\_**

**SCOPE OF WORK**

THE SUPPLIER / BIDDER TO BE AWARDED IS ANTICIPATED TO SUPPLY AND DELIVER SURGICAL INSTRUMENT AS PER SPECIFICATION BELOW.

TECHNICAL SPECIFICATION DETAILS		
1 *	<b>ARTERY FORCEPS STRAIGHT</b>	<p><b>Artery Forceps Straight:</b> Must be stainless steel; must be Auto-clavable and total length of 180mm.</p> 
2 *	<b>TENACULAM / VALCELUM</b>	<p><b>Teale Vulsellum Forceps:</b> Must be stainless steel; must be Auto-clavable; have 3x4 teeth that provide a secure grip; approx. 30cm and must Conform to ISO 9001.</p> 
4 *	<b>STITCH SCISSOR</b>	<p><b>Stitch Scissor:</b> Straight with smooth, sharp tips sides; must be stainless steel; must be Auto-clavable and must be 18cm in length.</p> 
5 *	<b>KIDNEY DISH - RECEIVER MEDIUM</b>	<ul style="list-style-type: none"> <li>Constructed of Stainless Steel.</li> <li>Medically approved standard – kidney shaped base and sloping walls used in medical and surgical procedure.</li> <li>Size : Medium – 25cm</li> <li>Ability to withstand high temperature – during autoclave process for decontamination.</li> </ul>
6 *	<b>KIDNEY DISH - RECEIVER LARGE</b>	<ul style="list-style-type: none"> <li>Constructed of Stainless Steel.</li> <li>Medically approved standard – kidney shaped base and sloping walls used in medical and surgical procedure.</li> <li>Size : Large – 30cm</li> <li>Ability to withstand high temperature – during autoclave process for decontamination.</li> </ul>
7 *	<b>6" [INCH] BOWL</b>	<p><b>6" [Inch] Bowl:</b> Must be stainless steel; must be Auto-clavable and total diameter of 160mm.</p> 

**AUTHORIZED / ENDORSED BY QUOTATION SPECIFICATION COMMITTEE**

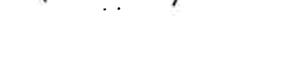
INITIALS AND SURNAME	PORTFOLIO	SIGNATURE
MR. MC MALUNGA	CHAIRPERSON	
MR. TO MAPHUMULO	MEMBER	
MRS. V RAMPERSAD	MEMBER	







TONGAAT COMMUNITY HEALTH CENTRE

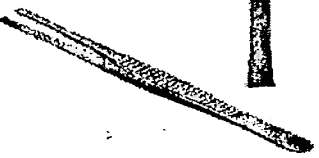
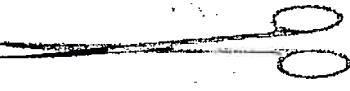

SPEC NO: QSN TCHC \_\_\_\_\_

**SCOPE OF WORK**

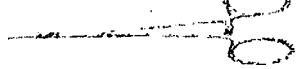
THE SUPPLIER / BIDDER TO BE AWARDED IS ANTICIPATED TO SUPPLY AND DELIVER SURGICAL INSTRUMENT AS PER SPECIFICATION BELOW.

TECHNICAL SPECIFICATION DETAILS		
8 *	<b>BOWL S/S : 240MM</b>	<b>Bowl:</b> Must be stainless steel; must be Auto-clavable and total diameter of 240mm. 
9 *	<b>DISSECTING FORCEPS NON-TOOTHED</b>	<b>Dissecting Forceps Non-toothed [Plain]:</b> <ul style="list-style-type: none"> <li>Stainless steel forceps plain.</li> <li>Must be Auto-clavable and total length of 150mm.</li> </ul> 
10 *	<b>DISSECTING FORCEPS TOOTHED</b>	<b>Dissecting Forceps Toothed:</b> <ul style="list-style-type: none"> <li>Stainless steel forceps with machined grip on arms with toothed points.</li> <li>Must be Auto-clavable and total length of 150mm.</li> </ul> 
3 *	<b>SCISSORS DRESSING</b>	<b>Scissors Dressing:</b> <ul style="list-style-type: none"> <li>Long Handle.</li> <li>Must be Auto-clavable and total length of 180mm.</li> <li>Blades: one rounded and the other sharp pointed.</li> </ul> 
11 *	<b>GALLIPOT</b>	<b>Gallipot:</b> Must be stainless steel; must be Auto-clavable and total diameter of 80mm. 
12 *	<b>MOSQUITO FORCEPS STRAIGHT</b>	<b>Mosquito Forceps Straight:</b> Must be stainless steel; must be Auto-clavable and total length of 12-15 cm. 

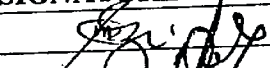
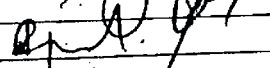
AUTHORIZED / ENDORSED BY QUOTATION SPECIFICATION COMMITTEE

INITIALS AND SURNAME	PORTFOLIO	SIGNATURE
MR. MC MALUNGA	CHAIRPERSON	
MR. TO MAPHUMULO	MEMBER	
MRS. V RAMPERSAD	MEMBER	



**health**

Department:  
Health  
PROVINCE OF KWAZULU-NATAL

DIRECTORATE:

Tongaat CHC, 07 Sanele Nxumalo Lane  
Tongaat  
4400  
Tel: 032 944 5054 Fax: 032 9451210



Quotation Specification  
Committee

TONGAAT COMMUNITY HEALTH CENTRE

SPEC NO: QSN TCHC \_\_\_\_\_

**SCOPE OF WORK**

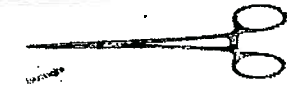
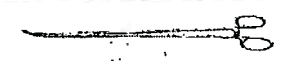
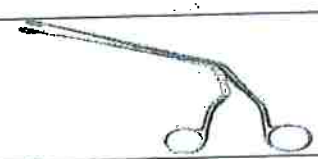
THE SUPPLIER / BIDDER TO BE AWARDED IS ANTICIPATED TO SUPPLY AND DELIVER SURGICAL INSTRUMENT AS PER SPECIFICATION BELOW.

TECHNICAL SPECIFICATION DETAILS		
13 *	<b>MOSQUITO FORCEPS CURVED</b>	<p><b>Mosquito Forceps Curved:</b> Must be stainless steel; must be Auto-clavable and total length of 12-15 cm.</p> 
16 *	<b>NEEDLE HOLDER, CRILE-WOOD</b>	<ul style="list-style-type: none"> <li>▪ NEEDLE HOLDER, CRILE-WOOD</li> <li>▪ Box joint</li> <li>▪ Tungsten Carbide Jaw Inserts</li> <li>▪ Stainless steel</li> <li>▪ Length: 200mm</li> <li>▪ Autoclavable, ISO 900101 &amp; ISO13485.</li> </ul>
17 *	<b>ARTERY FORCEPS STRAIGHT</b>	<p><b>Artery Forceps Straight:</b> Must be stainless steel; must be Auto-clavable and total length of 180mm.</p> 
18 *	<b>ARTERY FORCEPS CURVED</b>	<p><b>Artery Forceps Curved:</b> Must be stainless steel; must be Auto-clavable and total length of 180mm.</p> 
19 *	<b>MAGILL'S FORCEPS ADULT</b>	<p><b>Magill's Forceps Adult:</b></p> <ul style="list-style-type: none"> <li>• Must be stainless steel.</li> <li>• Must be Auto-clavable.</li> <li>• Must be SABS Approved.</li> </ul> 
20 *	<b>MAGILL'S FORCEPS CHILD</b>	<p><b>Magill's Forceps Child:</b></p> <ul style="list-style-type: none"> <li>• Must be stainless steel.</li> <li>• Must be Auto-clavable.</li> <li>• Must be SABS Approved.</li> </ul> 

**AUTHORIZED / ENDORSED BY QUOTATION SPECIFICATION COMMITTEE**

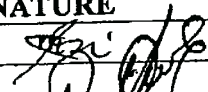
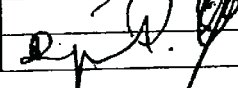
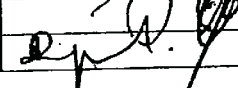
INITIALS AND SURNAME	PORTFOLIO	SIGNATURE
MR. MC MALUNGA	CHAIRPERSON	
MR. TO MAPHUMULO	MEMBER	
MRS. V RAMPERSAD	MEMBER	



Tongaat CHC, 07 Sanale Nxumalo Lane  
Tongaat  
4400  
Tel: 032 944 5054 Fax: 032 9451210 Email: Mondli.malunga@kznhealth.gov.za

Quotation Specification  
Committee

**TONGAAT COMMUNITY HEALTH CENTRE**

**SPEC NO: QSN TCHC \_\_\_\_\_**

**SCOPE OF WORK**

THE SUPPLIER / BIDDER TO BE AWARDED IS ANTICIPATED TO SUPPLY AND DELIVER SURGICAL INSTRUMENT AS PER SPECIFICATION BELOW.

**TECHNICAL SPECIFICATION DETAILS**

<p><b>SURGICAL INSTRUMENT TRAY</b></p>	<p><b>SURGICAL INSTRUMENT TRAY:</b></p> <ul style="list-style-type: none"> <li>▪ Must be stainless steel.</li> <li>▪ Must be Auto-clavable.</li> <li>▪ Must come with flat lid.</li> <li>▪ Must be 30*21cm size.</li> </ul>	
<p><b>BASIN LARGE</b></p>	<p><b>BASIN LARGE:</b></p> <ul style="list-style-type: none"> <li>▪ Dimensions approximately 420mm diamx150mm high.</li> <li>▪ Stainless steel and Autoclavable.</li> <li>▪ Used to hold obstetric instruments during sterilisation.</li> <li>▪ Once the pack is opened, filled with warm disinfectant solution for instrument and glove rinsing.</li> </ul> <p>Applicable Standards:</p> <ul style="list-style-type: none"> <li>▪ ISO 13402:1995: ISO 7153-1:2016: ISO900101 &amp; ISO13485.</li> </ul>	

**AUTHORIZED / ENDORSED BY QUOTATION SPECIFICATION COMMITTEE**

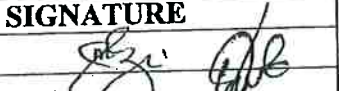
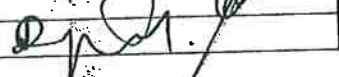
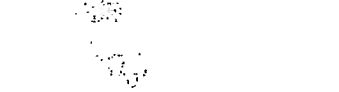
INITIALS AND SURNAME	PORTFOLIO	SIGNATURE
MR. MC MALUNGA	CHAIRPERSON	
MR. TO MAPHUMULO	MEMBER	
MRS. V RAMPERSAD	MEMBER	



Tongaat CHC, 07 Sanele Nxumalo Lane  
Tongaat  
4400  
Tel: 032 944 5054 Fax: 032 9451210

Quotation Specification  
Committee

**SPECIAL CONDITION OF BID / QUOTATION**

**1. SAMPLES**

1.1. The institution reserves the right to request the supplier to provide the picture of the item / to request an actual sample of the item to be supplied for quality testing / verification.

**2. STOCK AVAILABILITY**

2.1 The institution reserves the right to request the confirmation letter for stock availability before awarding the bid / quotation.

**3. DELIVERY ADHERENCE**

3.1. Delivery of the goods and performance of services shall be made by the supplier in accordance with the time schedule prescribed by the purchaser in the purchase order.

**4. PENALTY**

4.1. If the supplier fails to deliver any or all of the goods or to perform the services within the period(s) specified in the contract / order, the Institution shall, without prejudice to its other remedies, deduct from the contract / order price, as a penalty, a sum calculated on the delivered price of the delayed goods or unperformed services using the current prime interest rate calculated for each day of the delay until actual delivery or performance. The Institution may also consider termination of the contract / order pursuant to Clause 3.5 below.

**5. TERMINATION / CANCELLATION**

5.1. The Institution, without prejudice to any other remedy for breach of bid / quotation, by written notice of default sent to the supplier, may terminate this contract / order in whole or in part.  
A. If the supplier fails to deliver any or all of the goods within the period(s) specified in the contract / order; or within any extension thereof granted by the Institution;  
B. If the Supplier fails to perform any other obligation(s) under the contract / Specification / Quotation; or  
C. If the supplier, in the judgment of the Institution, has engaged in corrupt or fraudulent practices in competing for or in executing the contract / order.

**6. SUPPLIER'S / BIDDER'S DETAILS**

- 6.1. Initials and Surname \_\_\_\_\_
- 6.2. Position at the Company \_\_\_\_\_
- 6.3. Signature \_\_\_\_\_

**AUTHORIZED / ENDORSED BY QUOTATION SPECIFICATION COMMITTEE**

INITIALS AND SURNAME	PORTFOLIO	SIGNATURE
MR. MC MALUNGA	CHAIRPERSON	
MR. TO MAPHUMULO	MEMBER	
MRS. V RAMPERSAD	MEMBER	





**TONGAAT COMMUNITY HEALTH CENTRE**

**SPEC NO: QSN TCHC \_\_\_\_\_**

**SCOPE OF WORK**

THE SUPPLIER / BIDDER TO BE AWARDED IS ANTICIPATED TO SUPPLY AND DELIVER SURGICAL INSTRUMENT AS PER SPECIFICATION BELOW.

**TECHNICAL SPECIFICATION DETAILS**

<p>21 ✱</p> <p><b>SURGICAL INSTRUMENT TRAY</b></p>	<p><b>SURGICAL INSTRUMENT TRAY:</b></p> <ul style="list-style-type: none"> <li>▪ Must be stainless steel.</li> <li>▪ Must be Auto-clavable.</li> <li>▪ Must come with flat lid -183mm * 140*17mm.</li> </ul>	
<p> </p>		

**AUTHORIZED / ENDORSED BY QUOTATION SPECIFICATION COMMITTEE**

INITIALS AND SURNAME	PORTFOLIO	SIGNATURE
MR. MC MALUNGA	CHAIRPERSON	
MR. TO MAPHUMULO	MEMBER	
MRS. V RAMPERSAD	MEMBER	



Tongaat CHC, 07 Sanele Nxumalo Lane  
Tongaat  
4400  
Tel: 032 944 5054 Fax: 032 9451210 Email: Mondli.malunga@kznhealth.gov.za

Quotation Specification  
Committee



**TONGAAT COMMUNITY HEALTH CENTRE**

**SPEC NO: QSN TCHC \_\_\_\_\_**

**SCOPE OF WORK**

THE SUPPLIER / BIDDER TO BE AWARDED IS ANTICIPATED TO SUPPLY AND DELIVER SURGICAL INSTRUMENT AS PER SPECIFICATION BELOW.

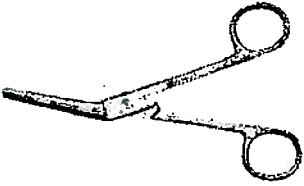
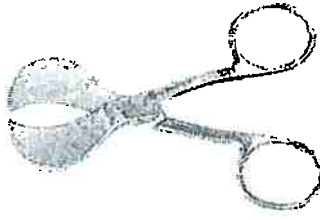
**TECHNICAL SPECIFICATION DETAILS**

<p>14 ✖</p> <p><b>EPISIOTOMY SCISSORS</b></p>	<ul style="list-style-type: none"> <li>• Constructed of Stainless Steel.</li> <li>• High quality cut</li> <li>• It has a slender sharp double-bevelled blade for precise cutting</li> <li>• Shorted flat blunt blade for support.</li> <li>• Sharp blades facilitate insertion in to the vagina.</li> <li>• Size : 67mm tip length (5.25mm tip width - 53mm tip length).</li> </ul>	
<p>15 ✖</p> <p><b>UMBILICAL CORD SCISSOR</b></p>	<ul style="list-style-type: none"> <li>▪ Umbilical cord scissor.</li> <li>▪ Size: 4" long.</li> <li>▪ Constructed from quality stainless steel.</li> <li>▪ The Pattern design must be crafted in the manner that reduces cord slippage and the sharp.</li> <li>▪ Blades must be precise to minimize tissue damage, which also reduces the risk of cord infection.</li> </ul>	
<p>22 ✖</p> <p><b>ROUND BOWL</b></p>	<ul style="list-style-type: none"> <li>▪ <b>Round bowl</b></li> <li>▪ Must be stainless steel.</li> <li>▪ Must be Auto-clavable and total diameter of 260mm.</li> </ul>	
<p>23 ✖</p> <p><b>EMERGENCY RESCUE SCISSOR.</b></p>	<ul style="list-style-type: none"> <li>▪ Emergency Rescue Scissor.</li> <li>▪ Sturdy plastic handle.</li> <li>▪ Blunt tip with snip protection.</li> <li>▪ Convenient angled design Excellent for cutting dressing and bandages.</li> <li>▪ Size : 190mm</li> </ul>	

**AUTHORIZED / ENDORSED BY QUOTATION SPECIFICATION COMMITTEE**

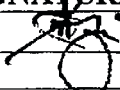
INITIALS AND SURNAME	PORTFOLIO	SIGNATURE
MR. MC MALUNGA	CHAIRPERSON	
MR. TO MAPHUMULO	MEMBER	
MRS. V RAMPERSAD	MEMBER	



**health**

Department:  
Health  
PROVINCE OF KWAZULU-NATAL

Tongaat CHC, 07 Sanele Nxumalo Lane  
Tongaat  
4400  
Tel: 032 944 5054 Fax: 032 9451210

**DIRECTORATE:**

Quotation Specification  
Committee

**TONGAAT COMMUNITY HEALTH CENTRE**

**SPEC NO: QSN TCHC \_\_\_\_\_**

**SCOPE OF WORK**

THE SUPPLIER / BIDDER TO BE AWARDED IS ANTICIPATED TO SUPPLY AND DELIVER SURGICAL INSTRUMENT AS PER SPECIFICATION BELOW.

**TECHNICAL SPECIFICATION DETAILS**

24 #  
**S SHAPED  
HOOKS.**

- S Shaped Hooks.
- Constructed of Stainless Steel.
- Silver in colour.
- Packed in 25 \* Hooks (Per Pack).
- Designed to handle heavier loads, sturdy and last for a long time.
- Be able to use for multiple purposes.

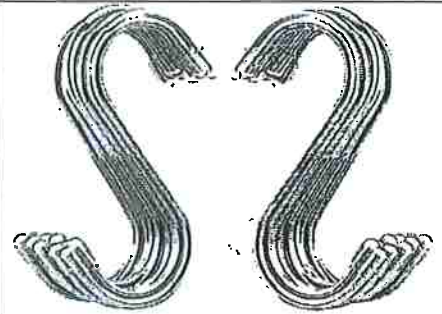

**AUTHORIZED / ENDORSED BY QUOTATION SPECIFICATION COMMITTEE**

INITIALS AND SURNAME	PORTFOLIO	SIGNATURE
MR. MC MALUNGA	CHAIRPERSON	
MR. TO MAPHUMULO	MEMBER	
MRS. V RAMPERSAD	MEMBER	



**health**

Department:  
Health  
PROVINCE OF KWAZULU-NATAL

Tongaat CHC, 07 Sanele Nxumalo Lane  
Tongaat  
4400  
Tel: 032 944 5054 Fax: 032 9451210

**DIRECTORATE:**

Quotation Specification  
Committee

**SPECIAL CONDITION OF BID / QUOTATION**

**1. SAMPLES**

1.1. The institution reserves the right to request the supplier to provide the picture of the item / to request an actual sample of the item to be supplied for quality testing / verification.

**2. STOCK AVAILABILITY**

2.1 The institution reserves the right to request the confirmation letter for stock availability before awarding the bid / quotation.

**3. DELIVERY ADHERENCE**

3.1. Delivery of the goods and performance of services shall be made by the supplier in accordance with the time schedule prescribed by the purchaser in the purchase order.

**4. PENALTY**

4.1. If the supplier fails to deliver any or all of the goods or to perform the services within the period(s) specified in the contract / order, the Institution shall, without prejudice to its other remedies, deduct from the contract / order price, as a penalty, a sum calculated on the delivered price of the delayed goods or unperformed services using the current prime interest rate calculated for each day of the delay until actual delivery or performance. The Institution may also consider termination of the contract / order pursuant to Clause 3.5 below.

**5. TERMINATION / CANCELLATION**

5.1. The Institution, without prejudice to any other remedy for breach of bid / quotation, by written notice of default sent to the supplier, may terminate this contract / order in whole or in part.  
A. If the supplier fails to deliver any or all of the goods within the period(s) specified in the contract / order, or within any extension thereof granted by the Institution;  
B. If the Supplier fails to perform any other obligation(s) under the contract / Specification / Quotation; or  
C. If the supplier, in the judgment of the Institution, has engaged in corrupt or fraudulent practices in competing for or in executing the contract / order.

**6. SUPPLIER'S / BIDDER'S DETAILS**

6.1. **Initials and Surname**

6.2. **Position at the Company**

6.3. **Signature**

\_\_\_\_\_  
\_\_\_\_\_  
\_\_\_\_\_

**AUTHORIZED / ENDORSED BY QUOTATION SPECIFICATION COMMITTEE**

INITIALS AND SURNAME	PORTFOLIO	SIGNATURE
MR. MC MALUNGA	CHAIRPERSON	
MR. TO MAPHUMULO	MEMBER	
MRS. V RAMPERSAD	MEMBER	